

Product range 4 Ball valves and Couplings



Article No. 41 – Ball valves

Technical Information

Ball valves for high pressure applications

General

Please ensure that the maximum pressure is in compliance with all connexions in the system.

Ball valves generally should not be utilised as throttle valves, therefore they should either be kept closed or open otherwise the ball seal might get damaged.

Please note particularly concerning long-term storages the ball valves should be arrested in open-position

Designation	Material
Body	Free cutting steel, brown-finished*
Sealing, stem	NBR
Stem	Free cutting steel, galvanised
Sealing, ball	Polyamide / POM
Ball	Free cutting steel, chrome plated

* also galvanised body available upon request

Technical information

The central feature of the **2/2 way and 3/2 way compact ball valves** is the floating ball sealing the system through an elastic and pre-stressed ball seal. Moreover this sealing function is enhanced by the actual system pressure. Also during vacuum and low pressure applications the pressure tightness of the system is guaranteed. Additionally an extended maintenance cycle is achieved.

However for the 3/2 compact ball valves a pressurisation should only be carried out via connexion port 1. In case of a pressurisation from any other port of the system a leak-free sealing can not be guaranteed. The leak-free sealing of the closed part can only be obtained if the pressure level is lower than on the pressure conveying side of the system.

Technical Information

Ball valves for high pressure applications

Characteristics

- A notch on the front of the stem enables an optical indication of switching position
- Stop pin and washer disk assure a switch limitation
- Manufacturers identification, manufacturing date as well as the operating pressure embossed on body

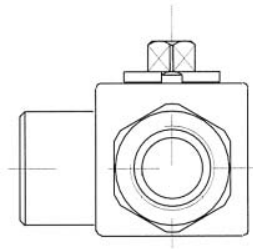
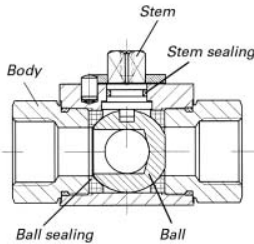

Standard switching positions:

3/2 with L-bore, 0 – 90°

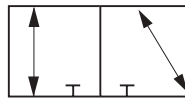
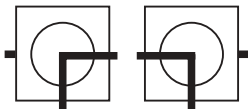

3/2 with T-bore, 0 – 90°

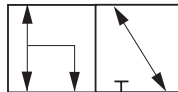
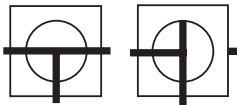

Manifold ball valves

For an unobjectionable and leakfree sealing pre-stressed and elastical plastic bushings are embedded centrally within the stem of the manifold ball valves.

The stem thereby can be operated by a square steel handle bar. The ball sealing is squeezed into position after operating pressure release. Adequately to a pressure increase the contact pressure augments as well. Also during vacuum and low pressure applications the pressure tightness of the system is guaranteed. The stem on the front is notched in order to facilitate an identification of the ball bore and the switching position. According to each individual implementation the handle bar can be mounted and shifted by 45°. The flow direction of the medium is not predetermined.

Technical Information

Ball valves for high pressure applications

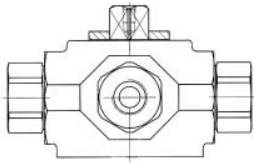

Standard position

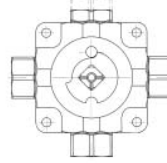

Switching position Intermediate position

3/2 with L bore, 0°-90°
positive overlap*

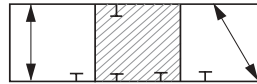

3/2 with T bore, 0°-90°
positive overlap*

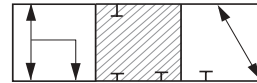

4/3 with L bore, 0°-45°- 90°

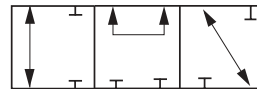

4/3 with T bore, 0°-45°- 90°
positive overlap*

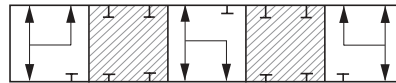

4/2 with X bore, 0°-90°

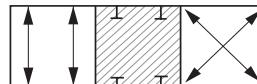

*Before initial operation please make sure that inputs and outputs are shut.
Further switching positions available on demand.

Technical Information

Ball valves for low pressure applications

Designation	Material
Sealing	PTFE
Ball	Hot pressed brass MS 58 chrome-plated
Stem	Hot pressed brass MS 58 MS 58
O-ring	NBR
Handle bar	Steel, galvanised
Handle	Aluminium (red, yellow DVGW*)
Bolt	Steel, galvanised

* German Technical and Scientific Association on Gas and Water

HANSA-FLEX ball valves for a low pressure applicatin range are suitable for industrial, pneumatics and hydraulic applications as well as for heating systems and sanitary facilities. Resistant towards hot water, wet steam, petrol, leadfree petrol with ethyl alcohol, heating oil, diesel, various oils, kerosene, acids, gases, compressed air etc. (unsuitable for methanol and saturated steam).

The operating pressure for gaseous mediums between PN 1 and PN 4 as well as for all further mediums should not exceed 32 bar.

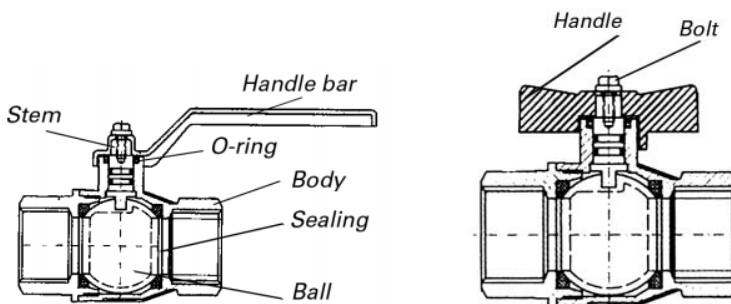

BKHL

Block ball valve BKH

For compression fittings, light series, DIN 2353, male metric thread, 24° seal

body: steel; ball: steel nickel pl.
stem: steel zinc pl.; ball sealing: POM (DIN 16); stem sealing: NBR
Article category 4101

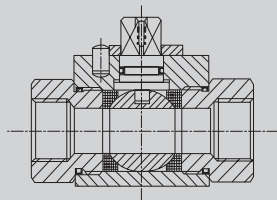

Disignation

DN

D

Tube O.D.

Nominal Pressure (bar)

BKHL 04	4	M 12x1,5	6	500
BKHL 06	6	M 14x1,5	8	500
BKHL 08	8	M 16x1,5	10	500
BKHL 10	10	M 18x1,5	12	500
BKHL 13	13	M 22x1,5	15	500
BKHL 16	16	M 26x1,5	18	500
BKHL 20	20	M 30x2	22	400
BKHL 25	25	M 36x2	28	350
BKHL 32	32	M 45x2	35	350
BKHL 40	40	M 52x2	42	350

BKHL A

Block ball valve BKH

For compression fittings, light series, DIN 2353

Block ball valve with fixation drill for ATLAS, male metric thread, light series, 24° sealing cone; body: steel; ball: steel nickel pl.; stem: steel zinc pl.; ball sealing: POM (DIN 16); stem sealing: NBR

Article category 4101

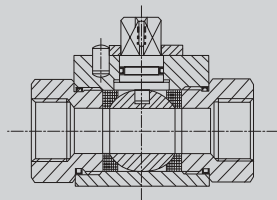

Disignation

DN

D

Tube O.D.

Nominal Pressure (bar)

BKHL 10 A

10

M 18x1,5

12

500

BKHS

Block ball valve BKH

metric male thread, 24° seal,
for compression fittings, heavy
series, DIN 2353

body: steel; ball: steel nickel pl.;
stem: steel zinc pl.; ball sealing:
POM; stem sealing: NBR

Article category 4104

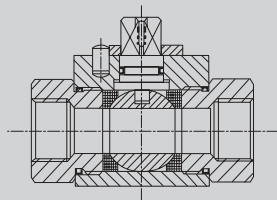

<i>Disignation</i>	<i>DN</i>	<i>D</i>	<i>Tube O.D.</i>	<i>Nominal Pressure (bar)</i>
--------------------	-----------	----------	------------------	-------------------------------

BKHS 04	4	M 16x1,5	8	500
BKHS 06	6	M 18x1,5	10	500
BKHS 08	8	M 20x1,5	12	500
BKHS 10	10	M 22x1,5	14	500
BKHS 13	13	M 24x1,5	16	500
BKHS 16	16	M 30x2	20	500
BKHS 20	20	M 36x2	25	400
BKHS 25	25	M 42x2	30	350
BKHS 32	32	M 52x2	38	320

BKN

Block ball valve BKN

with female NPT thread
ANSI B.2.1

body: steel

ball: steel nickel pl.

stem: steel zinc pl.

ball sealing: POM

stem sealing: NBR

Article category 4107

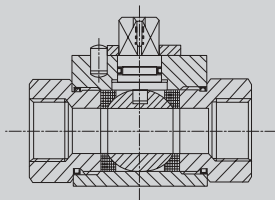

Disignation

DN

Connection thread IG-NPT

Nominal Pressure (bar)

BKN 06	6	1/4"	500
BKN 10	10	3/8"	500
BKN 13	13	1/2"	500
BKN 20	20	3/4"	400
BKN 25	25	1"	350
BKN 32	32	1"1/4	350

BKR

Block ball valve

with female NPT thread

body: steel

ball: steel nickel pl.

stem: steel zinc pl.

ball sealing: POM

stem sealing: NBR

DIN/ISO 228

Article category 4110

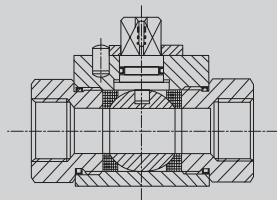

Designation

DN

Connection thread IG-NPT

Nominal Pressure (bar)

BKR 04	4	1/8"	500
BKR 06	6	G 1/4"	500
BKR 10	10	G 3/8"	500
BKR 13	13	G 1/2"	500
BKR 20	20	G 3/4"	400
BKR 25	25	G 1"	350
BKR 32	32	G 1 1/4"	350
BKR 40	40	G 1 1/2"	350

3 BKHL LK

3-way block ball valve

also applicable for lower pressure range, male metric thread, light series, 24° seal, metallic sealing, compact casing, L-drill, switch route 90°, case and stem NBR steel, switch ball hard-chromium plated POM; ball sealing: POM (DIN 16), stem sealing: NBR

Article category 4113

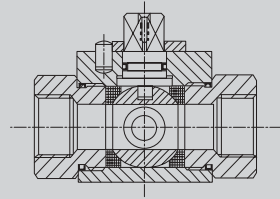

Disignation *DN* *Connection thread IG* *Tube O.D.* *Nominal Pressure (bar)*

3 BKHL 04 L K	4	M 12x1,5	6	400
3 BKHL 06 L K	6	M 14x1,5	8	400
3 BKHL 08 L K	8	M 16x1,5	10	400
3 BKHL 10 L K	10	M 18x1,5	12	400
3 BKHL 13 L K	13	M 22x1,5	15	350
3 BKHL 16 L K	16	M 26x1,5	18	350
3 BKHL 20 L K	20	M 30x2	22	350
3 BKHL 25 L K	25	M 36x2	28	350

3 BKHL TK

3-way block ball valve

also applicable for the lower pressure range, male metric thread, light series, 24° seal, metallic sealing, compact casing, T-drill, 90° switch route, case and stem NBR steel, switch ball hard-chromium plated POM; ball sealing: POM (DIN 16), stem sealing: NBR

Article category 4113

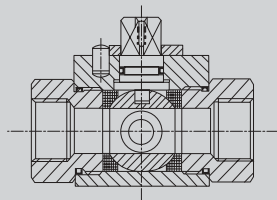

Disignation

DN

Connection thread IG

Tube O.D. Nominal Pressure (bar)

3 BKHL 08 T K	8	M 16x1,5	10	400
3 BKHL 10 T K	10	M 18x1,5	12	400
3 BKHL 13 T K	13	M 22x1,5	15	350
3 BKHL 16 T K	16	M 26x1,5	18	350

3 BKHS LK

3-way block ball valve

male metric thread, heavy series, 24° seal, compact casing, L-drill; switch route 90°, case and stem NBR steel, switch ball hard-chromium plated POM; ball sealing: POM (DIN 16), stem sealing: NBR

Article category 4113

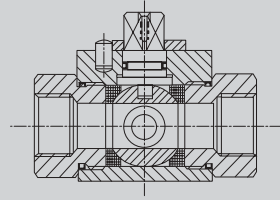

Disignation

DN

Connection thread IG

Tube O.D. Nominal Pressure (bar)

3 BKHS 04 L K	4	M 16x1,5	8	500
3 BKHS 06 L K	6	M 18x1,5	10	500
3 BKHS 08 L K	8	M 20x1,5	12	500
3 BKHS 10 L K	10	M 22x1,5	14	500
3 BKHS 13 L K	13	M 24x1,5	16	500
3 BKHS 16 L K	16	M 30x2	20	500
3 BKHS 20 L K	20	M 36x2	25	400
3 BKHS 25 L K	25	M 42x2	30	350

3 BKR LK

3-way block ball valve

also applicable for the lower pressure range, male metric thread, female BSP thread, seal necessary, thread has depth to be taken into consideration, compact casing, L-drill

Article category 4119

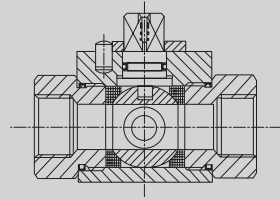

Designation

DN

Connection thread IG

Pressure (bar)

3 BKR 04 L K	4	G 1/8"	400
3 BKR 06 L K	6	G 1/4"	400
3 BKR 10 L K	10	G 3/8"	400
3 BKR 13 L K	13	G 1/2"	350
3 BKR 20 L K	20	G 3/4"	350
3 BKR 25 L K	25	G 1"	350

3 BKR TK

3-way block ball valve,
male metric thread, female
BSP thread, seal necessary,
thread depth to be taken into
consideration, compact case,
T-drill

Article category 4120

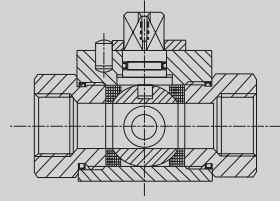

Disignation

DN

Connection thread IG

Nominal Pressure (bar)

3 BKR 10 T K

10

G 3/8"

350

3 BKR 13 T K

13

G 1/2"

350

3 BKHL L

3-way block ball valve

also applicable for the lower pressure range, male metric thread, light series, 24° seal, metallic sealing, L-drill, according to DIN 2353, body: steel; ball piston: steel nickel pl., ball sealing: POM, ball piston sealing: NBR

Article category 4123

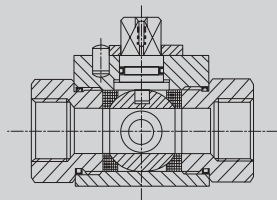

Disignation

DN

Connection thread IG

Tube O.D. Nominal Pressure (bar)

3 BKHL 04 L	4	M 12x1,5	6	500
3 BKHL 06 L	6	M 14x1,5	8	500
3 BKHL 08 L	8	M 16x1,5	10	500
3 BKHL 10 L	10	M 18x1,5	12	500
3 BKHL 13 L	13	M 22x1,5	15	500
3 BKHL 16 L	16	M 26x1,5	18	500
3 BKHL 20 L	20	M 30x2	22	400
3 BKHL 25 L	25	M 36x2	28	350
3 BKHL 32 L	32	M 45x2	35	350
3 BKHL 40 L	40	M 52x2	42	63

3 BKHS L

3-way block ball valve

male metric thread, heavy series, 24° seal, metallic sealing, L-drill, according to DIN 2353, body: steel, ball piston: steel nickel pl., ball sealing: POM, ball piston sealing: NBR

Article category 4126

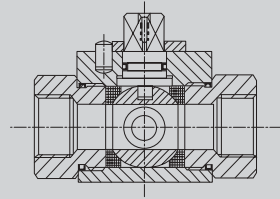

Disignation *DN* *Connection thread IG* *Tube O.D.* *Nominal Pressure (bar)*

3 BKHS 04 L	4	M 16x1,5	8	500
3 BKHS 06 L	6	M 18x1,5	10	500
3 BKHS 08 L	8	M 20x1,5	12	500
3 BKHS 10 L	10	M 22x1,5	14	500
3 BKHS 13 L	13	M 24x1,5	16	500
3 BKHS 16 L	16	M 30x2	20	500
3 BKHS 20 L	20	M 36x2	25	400
3 BKHS 25 L	25	M 42x2	30	350
3 BKHS 32 L	32	M 52x2	38	350

3 BKR L

3-way block ball valve

also applicable for the lower pressure range, female BSP thread, L-drill, thread according to DIN/ ISO 228, body: steel, ball piston: steel nickel pl., ball sealing: POM, ball piston sealing: NBR

Article category 4132

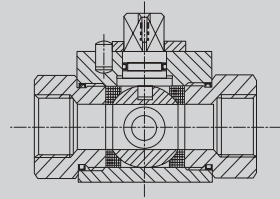

Disignation

DN

Connection thread IG

Nominal Pressure (bar)

3 BKR 04 L	4	G 1/8"	500
3 BKR 06 L	6	G 1/4"	500
3 BKR 10 L	10	G 3/8"	500
3 BKR 13 L	13	G 1/2"	400
3 BKR 20 L	20	G 3/4"	400
3 BKR 25 L	25	G 1"	350
3 BKR 32 L	32	G 1"1/4	350
3 BKR 40 L	40	G 1"1/2	63

3 BKHL T

3-way block ball valve

male metric thread, light series,
24° seal, metallic sealing, T-drill,
thread according to DIN/ ISO
228, body: steel, ball piston:
steel nickel pl., ball sealing: POM,
ball piston sealing: NBR
Article category 4159

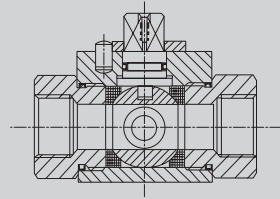

<i>Disignation</i>	<i>DN</i>	<i>Connection thread IG</i>	<i>Tube O.D.</i>	<i>Nominal Pressure (bar)</i>
--------------------	-----------	-----------------------------	------------------	-------------------------------

3 BKHL 04 T	4	M 12x1,5	6	500
3 BKHL 06 T	6	M 14x1,5	8	500
3 BKHL 08 T	8	M 16x1,5	10	500
3 BKHL 10 T	10	M 18x1,5	12	500
3 BKHL 13 T	13	M 22x1,5	15	500
3 BKHL 16 T	16	M 26x1,5	18	500
3 BKHL 20 T	20	M 30x2	22	400
3 BKHL 25 T	25	M 36x2	28	350
3 BKHL 32 T	32	M 45x2	35	350
3 BKHL 40 T	40	M 52x2	42	63

3 BKHS T

3-way block ball valve

also applicable for the lower pressure range, male metric thread, heavy series, 24° seal, metallic sealing, T-drill, according to DIN 2353, body: steel, ball piston: steel nickel pl., ball sealing: POM, ball piston sealing: NBR

Article category 4138

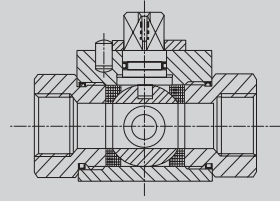

Disignation **DN** **Connection thread IG** **Tube O.D.** **Nominal Pressure (bar)**

3 BKHS 04 T	4	M 16x1,5	8	500
3 BKHS 06 T	6	M 18x1,5	10	500
3 BKHS 08 T	8	M 20x1,5	12	500
3 BKHS 10 T	10	M 22x1,5	14	500
3 BKHS 13 T	13	M 24x1,5	16	500
3 BKHS 16 T	16	M 30x2	20	500
3 BKHS 20 T	20	M 36x2	25	400
3 BKHS 25 T	25	M 42x2	30	350
3 BKHS 32 T	32	M 52x2	38	350

3 BKR T

3-way block ball valve

female BSP thread, seal necessary, thread depth to be taken into consideration, T-drill, thread according to DIN/ ISO 228, body: steel, ball piston: steel nickel pl., ball sealing: POM, ball piston sealing: NBR

Article category 4144

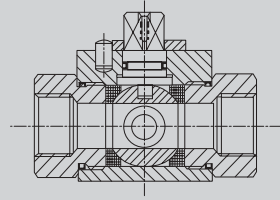

Disignation

DN

Connection thread IG

Nominal Pressure (bar)

3 BKR 04 T	4	G 1/8"	500
3 BKR 06 T	6	G 1/4"	500
3 BKR 10 T	10	G 3/8"	500
3 BKR 13 T	13	G 1/2"	400
3 BKR 20 T	20	G 3/4"	400
3 BKR 25 T	25	G 1"	350
3 BKR 32 T	32	G 1"1/4	350
3 BKR 40 T	40	G 1"1/2	63

4 BKHL L

4-way block ball valve

male metric thread, light series,
24° seal, metallic sealing, L-drill

Article category 4147

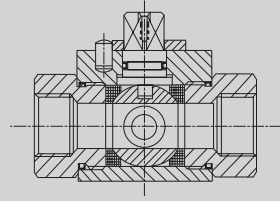

<i>Disignation</i>	<i>DN</i>	<i>Connection thread IG</i>	<i>Tube O.D.</i>	<i>Nominal Pressure (bar)</i>
--------------------	-----------	-----------------------------	------------------	-------------------------------

4 BKHL 04 L	4	M 12x1,5	6	500
4 BKHL 06 L	6	M 14x1,5	8	500
4 BKHL 08 L	8	M 16x1,5	10	500
4 BKHL 10 L	10	M 18x1,5	12	500
4 BKHL 13 L	13	M 22x1,5	15	400
4 BKHL 16 L	16	M 26x1,5	18	400
4 BKHL 20 L	20	M 30x2	22	350
4 BKHL 25 L	25	M 36x2	28	350
4 BKHL 32 L	32	M 45x2	35	350
4 BKHL 40 L	40	M 52x2	42	63

4 BKHS L

4-way block ball valve

male metric thread, heavy series,
24° seal, metallic sealing, L-drill;
according to DIN 2353

body: steel; ball piston: steel nickel
pl.; ball sealing: POM; ball piston
sealing: NBR

Article category 4150

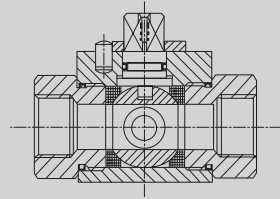

Disignation *DN* *Connection thread IG* *Tube O.D.* *Nominal Pressure (bar)*

4 BKHS 04 L	4	M 16x1,5	8	500
4 BKHS 06 L	6	M 18x1,5	10	500
4 BKHS 08 L	8	M 20x1,5	12	500
4 BKHS 10 L	10	M 22x1,5	14	500
4 BKHS 13 L	13	M 24x1,5	16	400
4 BKHS 16 L	16	M 30x2	20	400
4 BKHS 20 L	20	M 36x2	25	350
4 BKHS 25 L	25	M 42x2	30	350
4 BKHS 32 L	32	M 52x2	38	350

4 BKR L

4-way block ball valve

Female BSP thread, seal necessary, thread depth has to be taken into consideration, L-drill, according to DIN/ ISO 228,

body: steel

ball piston: steel nickel pl.

ball sealing: POM

ball piston sealing: NBR

Article category 4156

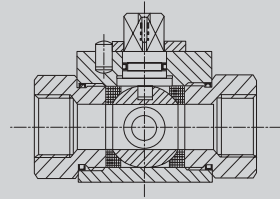

Designation

DN

Connection thread IG

Nominal Pressure (bar)

4 BKR 04 L	4	G 1/8"	500
4 BKR 06 L	6	G 1/4"	500
4 BKR 10 L	10	G 3/8"	500
4 BKR 13 L	13	G 1/2"	400
4 BKR 20 L	20	G 3/4"	400
4 BKR 25 L	25	G 1"	350
4 BKR 32 L	32	G 1"1/4	350
4 BKR 40 L	40	G 1"1/2	63

4 BKHL T

4-way block ball valve

male metric thread, light series,
24° seal, metallic sealing, T-drill,
according to DIN 2353

body: steel

ball piston: steel nickel pl.

ball sealing: POM

ball piston sealing: NBR

Article category 4159

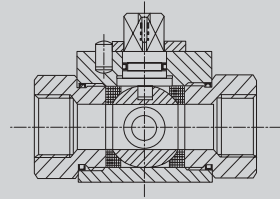

Disignation **DN** **Connection thread IG** **Tube O.D.** **Nominal Pressure (bar)**

4 BKHL 04 T	4	M 12x1,5	6	500
4 BKHL 06 T	6	M 14x1,5	8	500
4 BKHL 08 T	8	M 16x1,5	10	500
4 BKHL 10 T	10	M 18x1,5	12	500
4 BKHL 13 T	13	M 22x1,5	15	400
4 BKHL 16 T	16	M 26x1,5	18	400
4 BKHL 20 T	20	M 30x2	22	400
4 BKHL 25 T	25	M 36x2	28	350
4 BKHL 32 T	32	M 45x2	35	350
4 BKHL 40 T	40	M 52x2	42	63

4 BKHS T

4-way block ball valve

male metric thread, heavy series,
24° seal, metallic sealing, T-drill,
according to DIN 2353,

body: steel

ball piston: steel nickel pl.

ball sealing: POM

ball piston sealing: NBR

Article category 4162

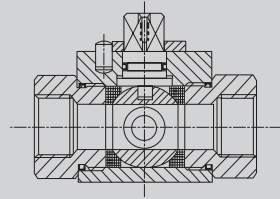

Disignation

DN

Connection thread IG

Tube O.D. Nominal Pressure (bar)

4 BKHS 04 T	4	M 16x1,5	8	500
4 BKHS 06 T	6	M 18x1,5	10	500
4 BKHS 08 T	8	M 20x1,5	12	500
4 BKHS 10 T	10	M 22x1,5	14	500
4 BKHS 13 T	13	M 24x1,5	16	400
4 BKHS 16 T	16	M 30x2	20	400
4 BKHS 20 T	20	M 36x2	25	400
4 BKHS 25 T	25	M 42x2	30	350
4 BKHS 32 T	40	M 52x2	38	350

4 BKR T

4-way block ball valve

female BSP thread, seal necessary,
thread depth has to be taken into
consideration, T-drill, according
to DIN/ ISO 228

body: steel
ball piston: steel nickel pl.
ball sealing: POM
ball piston sealing: NBR

Article category 4168

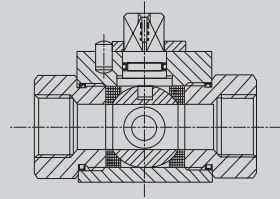

<i>Disignation</i>	<i>DN</i>	<i>Connection thread IG</i>	<i>Tube O.D.</i>	<i>Nominal Pressure (bar)</i>
--------------------	-----------	-----------------------------	------------------	-------------------------------

4 BKR 04 T	4	3	G 1/8"	500
4 BKR 06 T	6	4	G 1/4"	500
4 BKR 10 T	10	6	G 3/8"	500
4 BKR 13 T	13	8	G 1/2"	400
4 BKR 20 T	20	12	G 3/4"	400
4 BKR 25 T	25	16	G 1"	350
4 BKR 32 T	32	20	G 1"1/4	350
4 BKR 40 T	40	24	G 1"1/2	63

4 BKHL X

4-way block ball valve

male metric thread, light series,
24° seal, metallic sealing, X-drill,
according to DIN 2353,

body: steel

ball piston: steel nickel pl.

ball sealing: POM

ball piston sealing: NBR

Article category 4171

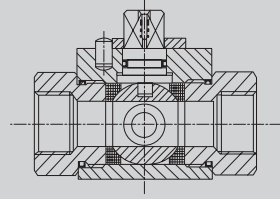

Disignation *DN* *Connection thread IG* *Tube O.D.* *Nominal Pressure (bar)*

4 BKHL 04 X	4	M 12x1,5	6	500
4 BKHL 06 X	6	M 14x1,5	8	500
4 BKHL 08 X	8	M 16x1,5	10	500
4 BKHL 10 X	10	M 18x1,5	12	500
4 BKHL 13 X	13	M 22x1,5	15	400
4 BKHL 16 X	16	M 26x1,5	18	400
4 BKHL 20 X	20	M 30x2	22	400
4 BKHL 25 X	25	M 36x2	28	350
4 BKHL 32 X	32	M 45x2	35	350
4 BKHL 40 X	40	M 52x2	42	63

4 BKHS X

4-way block ball valve

male metric thread, heavy series,
24° seal, metallic sealing,

X-drill, according to DIN 2353,
body: steel

ball piston: steel nickel pl.

ball sealing: POM

ball piston sealing: NBR

Article category 4174

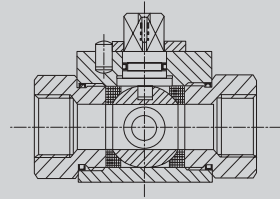

Disignation

DN

Connection thread IG

Tube O.D. Nominal Pressure (bar)

4 BKHS 04 X	4	M 16x1,5	8	500
4 BKHS 06 X	6	M 18x1,5	10	500
4 BKHS 08 X	8	M 20x1,5	12	500
4 BKHS 10 X	10	M 22x1,5	14	500
4 BKHS 13 X	13	M 24x1,5	16	400
4 BKHS 16 X	16	M 30x2	20	400
4 BKHS 20 X	20	M 36x2	25	400
4 BKHS 25 X	25	M 42x2	30	350
4 BKHS 32 X	32	M 52x2	38	350

4 BKR X

4-way block ball valve

female BSP thread, seal necessary, thread depth has to be taken into consideration, X-drill, according to DIN/ ISO 228

body: steel
ball piston: steel nickel pl.
ball sealing: POM
ball piston sealing: NBR

Article category 4180

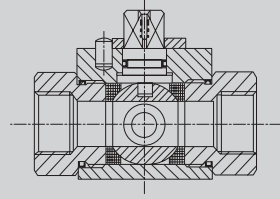

Disignation

DN

Connection thread IG

Nominal Pressure (bar)

4 BKR 04 X	4	G 1/8"	500
4 BKR 06 X	6	G 1/4"	500
4 BKR 10 X	10	G 3/8"	500
4 BKR 13 X	13	G 1/2"	400
4 BKR 20 X	20	G 3/4"	400
4 BKR 25 X	25	G 1"	350
4 BKR 32 X	32	G 1"1/4	350
4 BKR 40 X	40	G 1"1/2	63

BK ALU GRIFF SW

Handle bar for ball valve

straight, aluminium, red anodised

Article category 4183

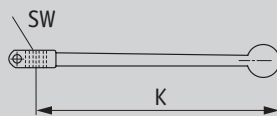

Disignation

SW

K

BK ALU GRIFF SW 9	9	150
BK ALU GRIFF SW 12	12	175
BK ALU GRIFF SW 14	14	200
BK ALU GRIFF SW 17	17	280
BK ALU GRIFF SW 19	19	300

BK GEKR GRIFF SW

Handle bar for ball valve

bent, zinc die casted, width
across flat 17 steel

Article category 4183

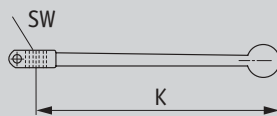

Disignation

SW

K

BK GEKR GRIFF SW 9	9	107
BK GEKR GRIFF SW 12	12	165
BK GEKR GRIFF SW 14	14	165
BK GEKR GRIFF SW 17	17	211
BK GEKR GRIFF SW 19	19	211

BKR ND K

Block ball valve for lower pressure range, brass

Female BSP thread, seal necessary, take thread depth into consideration, low pressure ranges, compact handle bar, working temperature ranges: between -15°C and +150°C, valve body: hot pressed brass OT 58, handle bar: aluminium, ball: hard chrome plated hot pressed brass OT 58, seal: Teflon, stem: hot pressed brass OT 58; O-ring: Teflon, stem seal: hot pressed brass OT 58

Article category 4184

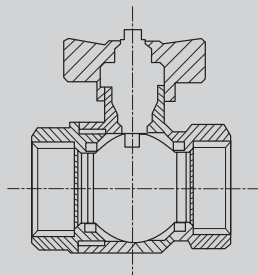

Disignation

DN

Connection thread (BSP)

Pressure (bar)

BKR 06 ND K	6	G 1/4"	50
BKR 10 ND K	10	G 3/8"	50
BKR 13 ND K	13	G 1/2"	50
BKR 20 ND K	20	G 3/4"	40
BKR 25 ND K	25	G 1"	40

BKR ND

Block ball valve for lower pressure range, brass

Female BSP thread, seal necessary, take thread depth into consideration, low pressure ranges, 2-and 3-ways ball valve, hot-pressed brass nickel-plated, working temperature ranges: between -15°C and +150°C, valve body: hot-pressed brass OT 58, handle bar: aluminium, ball: chrome plated hot-pressed brass OT 58, seal: Teflon, stem: hot pressed brass OT 58, O-ring: teflon, stem seal: hot-pressed brass OT 58

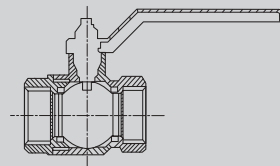

Article category 4185

Designation

DN

Connection thread (BSP)

Pressure (bar)

BKR 06 ND	6	G 1/4"	50
BKR 10 ND	10	G 3/8"	50
BKR 13 ND	12	G 1/2"	50
BKR 20 ND	20	G 3/4"	40
BKR 25 ND	25	G 1"	40
BKR 32 ND	32	G 1"1/4	30
BKR 40 ND	40	G 1"1/2	30
BKR 50 ND	50	G 2"	25
BKR 65 ND	60	G 2"1/2	18
BKR 75 ND	75	G 3"	16
BKR 100 ND	100	G 4"	14

BKR ND ROV

Block ball valve for lower pressure range, brass

Female BSP thread with thread depth for tube connections according to DIN 2999, working temperature ranges: between -15°C and +150°C, valve body: hot-pressed brass OT 58, handle bar: zinc-plated and varnished steel, ball: chrome plated hot-pressed brass OT 58, seal: pure teflon, stem: hot pressed brass OT 58, O-ring: Teflon, stem seal: brass OT 58, 2 O-ring: NBR nitrilic rubber/ viton

Article category 4186

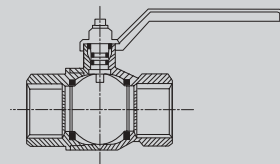

Disignation

DN

Connection thread (BSP)

Pressure (bar)

BKR 06 ND ROV	6	G 1/4"	50
BKR 10 ND ROV	10	G 3/8"	50
BKR 13 ND ROV	13	G 1/2"	50
BKR 20 ND ROV	20	G 3/4"	40
BKR 25 ND ROV	25	G 1"	40
BKR 32 ND ROV	32	G 1"1/4	30
BKR 40 ND ROV	40	G 1"1/2	30
BKR 50 ND ROV	50	G 2"	25

BKR HR ND

Block ball valve for lower pressure range, brass

Female BSP thread, nominal pressure as well as thread depth have to be taken into consideration, male BSP thread, flat sealing, 2-and 3-ways ball valve, nickel-plated hot-pressed brass; working temperature ranges: between -15°C and +150°C, valve body: hot-pressed brass OT 58, handle bar: aluminium, ball: chrome plated, hot-pressed brass OT 58, seal: teflon, stem: hot pressed brass OT 58; O-ring: Teflon, stem seal: brass OT 58

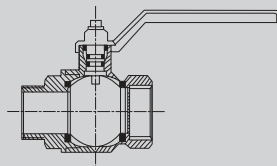

Article category 4187

Designation

DN

Connection thread (BSP)

Pressure (bar)

BKR 06 HR ND	6	G 1/4"	50
BKR 10 HR ND	10	G 3/8"	50
BKR 13 HR ND	13	G 1/2"	50
BKR 20 HR ND	20	G 3/4"	40
BKR 25 HR ND	25	G 1"	40
BKR 32 HR ND	32	G 1"1/4	30
BKR 40 HR ND	40	G 1"1/2	30
BKR 50 HR ND	50	G 2"	25

BKR ND DVGW

Block ball valve for lower pressure range, brass

Female BSP thread, DVGW-licensed, yellow key, thread depth according to DIN 2999; working temperature ranges: between -15°C and +150°C, water between 0 and +150°C, not applicable for vapour, valve body: hot pressed brass OT 58, handle bar: zinc-plated and varnished steel, ball: hard chrome plated hot pressed brass OT 58, seal: pure teflon (P.T.F.E), stem: brass OT 58, O-ring: NBR nitrilic rubber/ viton

Article category 4188

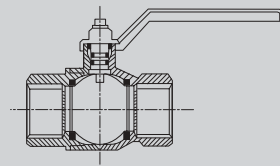

Disignation

DN

Connection thread (BSP)

Pressure (bar)

BKR 06 ND DVGW	6	G 1/4"	50
BKR 10 ND DVGW	10	G 3/8"	50
BKR 13 ND DVGW	13	G 1/2"	50
BKR 20 ND DVGW	20	G 3/4"	40
BKR 25 ND DVGW	25	G 1"	40
BKR 32 ND DVGW	32	G 1 1/4"	30
BKR 40 ND DVGW	40	G 1 1/2"	30
BKR 50 ND DVGW	50	G 2"	25

3 BKR ND L

Block ball valve for lower pressure range, brass

3-way ball valve, female BSP thread, sealing necessary, hot-pressed nickel-plated brass, L-drill; working temperature ranges: between -15°C and +150°C, valve body: nickel-plated brass OT 58, handle bar: aluminium, red, ball: hard-chromed brass OT 58, seals: teflon (P.T.F.E.), stem: brass OT 58, stem seal: viton

Article category 4189

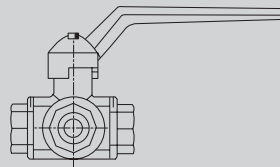

Disignation

DN

Connection thread (BSP)

Nominal Pressure (bar)

3 BKR 06 ND L	6	G 1/4"	25
3 BKR 10 ND L	10	G 3/8"	25
3 BKR 13 ND L	13	G 1/2"	25
3 BKR 20 ND L	20	G 3/4"	25
3 BKR 25 ND L	25	G 1"	25
3 BKR 32 ND L	32	G 1"1/4	25
3 BKR 40 ND L	40	G 1"1/2	25
3 BKR 50 ND L	50	G 2"	25

3 BKR ND T

Block ball valve for lower pressure range

3-way-ball valve, female BSP thread, sealing necessary, hot-pressed nickel-plated brass, T-drill; valve body: nickel-plated brass OT 58, handle bar: aluminium, red, ball: hard-chromed brass OT 58, seals: teflon (P.T.F.E.), stem: brass OT 58, stem seal: viton

Article category 4190

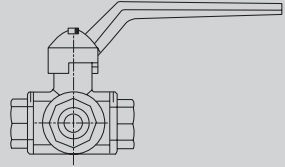

Disignation

DN

Connection thread (BSP)

Pressure (bar)

3 BKR 06 ND T	6	G 1/4"	25
3 BKR 10 ND T	10	G 3/8"	25
3 BKR 13 ND T	13	G 1/2"	25
3 BKR 20 ND T	20	G 3/4"	25
3 BKR 25 ND T	25	G 1"	25
3 BKR 32 ND T	32	G 1 1/4"	25
3 BKR 40 ND T	40	G 1 1/2"	25
3 BKR 50 ND T	50	G 2"	25

BK GFS

Block ball valve, SAE counter flange

Working pressure according to ISO 6162.2. Flange dimensions 3000 psi

body: steel; ball: steel nickel pl.
stem: steel zinc pl.; ball sealing: POM; stem sealing: NBR

Article category 4191

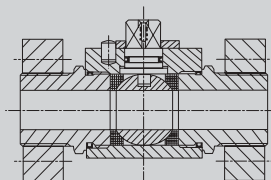

Disignation

DN

Size

Flange

Pressure (bar)

BK GFS 20

20

12

3/4"

315

BK GFS 25

25

16

1"

315

BK GFS 32

32

20

1"1/4

250

SK GFS

Ball valve forged type

SAE counter flange

Flange dimensions: 3000 psi,
working pressure according to ISO
6162.2

body: steel; ball: steel nickel pl.;
stem: steel zinc pl.; ball sealing:
POM; stem sealing: NBRM

Article category 4191

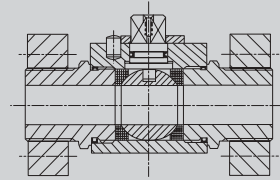

<i>Disignation</i>	<i>DN</i>	<i>Size</i>	<i>Flange</i>	<i>Pressure (bar)</i>
--------------------	-----------	-------------	---------------	-----------------------

SK GFS 32	32	20	1"1/4	250
SK GFS 40	40	24	1"1/2	200
SK GFS 50	50	32	2"	200

BK GFS 6

Block ball valve, SAE counter flange

Flange dimensions: 6000 psi, working pressure according to ISO 6162.2

body: steel; ball: steel nickel pl.; stem: steel zinc pl.; ball sealing: POM; stem sealing: NBR

Article category 4192

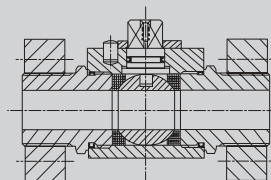

Disignation

DN

Size

Flange

Pressure (bar)

BK GFS 6 20

20

12

3/4"

400

BK GFS 6 25

25

16

1"

400

SK GFS 6

Ball valve forged type, SAE counter flange

Flange dimensions: 6000 psi, working pressure according to ISO 6162.2

Body: steel; ball: steel nickel pl.
stem: steel zinc pl.
ball sealing: POM
stem sealing: NBR

Article category 4192

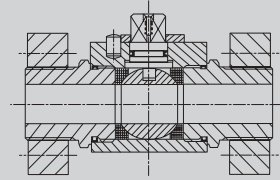

Disignation

DN

Size

Flange

Pressure (bar)

SK GFS 6 32	32	20	1"1/4	400
SK GFS 6 40	40	24	1"1/2	400
SK GFS 6 50	50	32	2"	400

BK SF

Block ball valve

SAE flange

Flange dimensions: 3000 psi,
working pressure according to ISO
6162.2

Body: steel; ball: steel nickel pl.;
stem: steel zinc pl.; ball sealing:
POM; stem sealing: NBR

Article category 4193

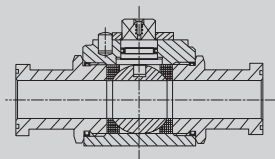

Disignation

DN

Size

Flange

Pressure (bar)

BK SF 20

20

12

3/4"

315

BK SF 25

25

16

1"

315

SK SF

Ball valve forged type

SAE flange

Flange dimensions: 3000 psi, working pressure according to ISO 6162.2

Body: steel

ball: steel nickel pl.

stem: steel zinc pl.

ball sealing: POM

stem sealing: NBR

Article category 4193

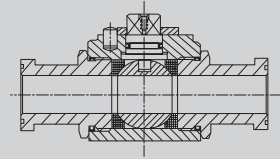

<i>Disignation</i>	<i>DN</i>	<i>Size</i>	<i>Flange</i>	<i>Pressure (bar)</i>
--------------------	-----------	-------------	---------------	-----------------------

SK SF 32	32	20	1"1/4	250
SK SF 40	40	24	1"1/2	200
SK SF 50	50	32	2"	200

BK SF 6

Block ball valve

SAE flange

Flange dimensions: 6000 psi,
working pressure according to ISO
6162.2

Body: steel; ball: steel nickel pl.
stem: steel zinc pl.; ball sealing:
POM; stem sealing: NBR

Article category 4194

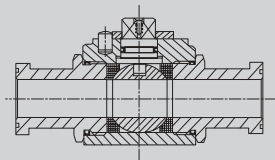

Disignation

DN

Size

Flange

Pressure (bar)

BK SF 6 20

20

12

3/4"

400

BK SF 6 25

25

16

1"

400

SK SF 6

Ball valve forged type

SAE flange

Flange dimensions: 6000 psi,
working pressure according to ISO
6162.2

Body: steel; ball: steel nickel pl.;
stem: steel zinc pl.; ball sealing:
POM; stem sealing: NBR

Article category 4194

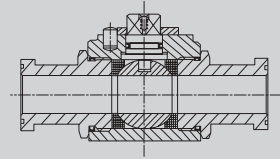

Disignation

DN

Size

Flange

Pressure (bar)

SK SF 6 32

32

20

1"1/4

400

SK SF 6 40

40

24

1"1/2

400

SK SF 6 50

50

32

2"

400

BK SF GFS

Block ball valve

SAE flange

Flange dimensions: 3000 psi,
working pressure according to ISO
6162.2

Body: steel; ball: steel nickel pl.;
stem: steel zinc pl.; ball sealing:
POM; stem sealing: NBR

Article category 4195

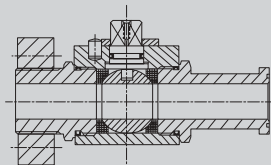

<i>Disignation</i>	<i>DN</i>	<i>Size</i>	<i>Flange</i>	<i>Pressure (bar)</i>
--------------------	-----------	-------------	---------------	-----------------------

BK SF 20 GFS	20	12	3/4"	315
BK SF 25 GFS	25	16	1"	315

SK SF GFS

Ball valve forged type

SAE counter flange

Flange dimensions: 3000 psi,
working pressure according to ISO
6162.2

Body: steel; ball: steel nickel pl.;
stem: steel zinc pl.; ball sealing:
POM; stem sealing: NBR

Article category 4195

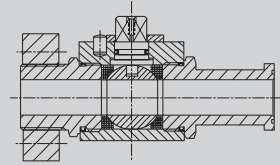

<i>Disignation</i>	<i>DN</i>	<i>Size</i>	<i>Flange</i>	<i>Nominal Pressure (bar)</i>
--------------------	-----------	-------------	---------------	-------------------------------

SK SF 32 GFS	32	20	1"1/4	250
SK SF 40 GFS	40	24	1"1/2	200
SK SF 50 GFS	50	32	2"	200

BK SF 6 GFS

Block ball valve

SAE counter flange, Flange dimensions: 6000 psi, working pressure according to ISO 6162.2

Body: steel; ball: steel nickel pl.; stem: steel zinc pl.; ball sealing: POM; stem sealing: NBR

Article category 4196

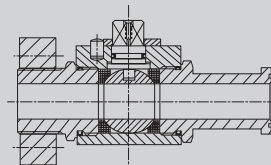

<i>Disignation</i>	<i>DN</i>	<i>Size</i>	<i>Flange</i>	<i>Nominal Pressure (bar)</i>
--------------------	-----------	-------------	---------------	-------------------------------

BK SF 620 GFS	20	12	3/4"	400
BK SF 625 GFS	25	16	1"	400

SK SF 6 GFS

Ball valve forged type

SAE flange, Flange dimensions: 6000 psi, working pressure according to ISO 6162.2

Body: steel; ball: steel nickel pl.; stem: steel zinc pl.; ball sealing: POM

stem sealing: NBR

Article category 4196

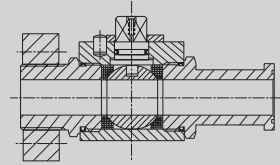

<i>Disignation</i>	<i>DN</i>	<i>Size</i>	<i>Flange</i>	<i>Nominal Pressure (bar)</i>
--------------------	-----------	-------------	---------------	-------------------------------

SK SF 632 GFS	32	20	1"1/4	400
SK SF 640 GFS	40	24	1"1/2	400
SK SF 650 GFS	50	32	2"	400

MF MG

Sliding socket

with female BSP thread,
no threaded depth for tube
connection according to DIN
2353; material: brass, valve body:
hot pressed brass, wheel: steel,
bonnet: brass OT 58, stem: brass
OT 58

Article category 4198

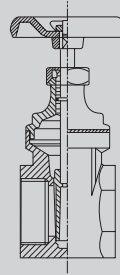

Designation

DN

Size

Pressure (bar)

MF 06 MG	6	4	10
MF 10 MG	10	6	10
MF 13 MG	13	8	10
MF 20 MG	20	12	10
MF 25 MG	25	16	10
MF 32 MG	32	20	10
MF 40 MG	40	24	10
MF 50 MG	50	32	10
MF 65 MG	60	40	10
MF 75 MG	75	48	10
MF 100 MG	100	64	10

ND GRIFF

Spare handle bar

for low pressure ball valve

Article category 4199



Disignation

Dimension

Inch

ND GRIFF DN 0613	6 bis 13	1/4"-1/2"
ND GRIFF DN 100	100	3"-4"
ND GRIFF DN 2025	20 bis 25	3/4"-1"
ND GRIFF DN 3240	32 bis 40	1"1/4-1"1/2
ND GRIFF DN 50	50	2"
ND GRIFF DN 65	65	2"1/2

Index

3

3-way block ball valve	11-21
3 BKHL L	16
3 BKHL LK	11
3 BKHL T	19
3 BKHL TK	12
3 BKHS L	17
3 BKHS LK	13
3 BKHS T	20
3 BKR L	18
3 BKR LK	14
3 BKR ND L	38
3 BKR ND T	39
3 BKR T	21
3 BKR TK	15

4

4-way block ball valve	22-30
4 BKHL L	22
4 BKHL T	25
4 BKHL X	28
4 BKHS L	23
4 BKHS T	26
4 BKHS X	29
4 BKR L	24
4 BKR T	27
4 BKR X	30

B

Ball valve forged type	41
Ball valve forged type	45
Ball valve forged type	47
Ball valve forged type	49
Ball valve forged type	51
Ball valve forged type, SAE counter flange	43
BKHL	6
BKHL A	7
BKHS	8
BKN	9
BKR	10
BKR HR ND	36
BKR ND	34
BKR ND DVGW	37
BKR ND K	33
BKR ND ROV	35
BK ALU GRIFF SW	31
BK GEKR GRIFF SW	32
BK GFS	40
BK GFS 6	42
BK SF	44
BK SF 6	46
BK SF 6 GFS	50
BK SF GFS	48
Block ball valve	10

Index

Block ball valve	44
Block ball valve	46
Block ball valve	48
Block ball valve	50
Block ball valve, SAE counter flange	40
Block ball valve, SAE counter flange	42
Block ball valve BKH	6-9
Block ball valve for lower pressure range, brass	33-38
Block ball valve for lower pressure range	39

H

Handle bar for ball valve	31-32
---------------------------	-------

M

MF MG	52
-------	----

N

ND GRIFF	53
----------	----

S

SK GFS	41
SK GFS 6	43
SK SF	45
SK SF 6	47
SK SF 6 GFS	51
SK SF GFS	49
Sliding socket	52
Spare handle bar	53