

*Technical Information*  
**HANSA-FLEX Hose Connections**



# Technical Information

## HANSA-FLEX Hose Connections

### 1.1 Introduction

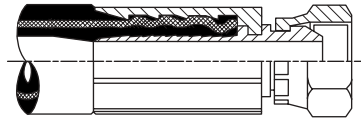

Hydraulic hoses and hose assemblies represent the core of the HANSA-FLEX product range and have proved a success in millions of technical applications since the beginning of our business activities. This segment of our programme comprises fittings manufactured according to worldwide valid industrial standards, the number of possible applications is unlimited for our standard swage fittings, interlock or reusable fittings. As even experienced users get confused by the variety of different fluid connector types we would like to give a guidance and explain the most frequently asked questions from our daily business activities. The correct choice of a hydraulic hose hereby is crucial in order to ensure a secure and reliable operating system.

Criteria for the right hose choice as well as for the construction are displayed with the following bullet points:

- consistence towards the fluid, take respective cleaning process into consideration!
- temperature persistence, hereby it is important to double check the correlation between temperature and pressure characteristics
- bending radius
- are particular load or stress requirements via external pressure impulses or forces applied?
- abrasion performance and possible protection
- mounting conditions i.e. motion sequence, bending, whipping, indication, twisting angles of the bending armatures, leg length
- secure sealing (heading formation)

## Technical Information

### HANSA-FLEX Hose Connections

#### 1.2 Design and function of hydraulic hose fittings

Hose fittings form a reliable connection between the hose material and the attached sealing cones of the various conducting components. The first assemblies were developed in the US of A about 50 years ago and got since then rather rapidly established within this specific niche well until the 70s and represented a wide-scattered spectrum within the market.

Ferrule and nipple are assembled on the hose material using internal and external threads as shown below:

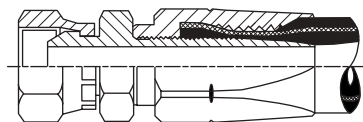

These fitting types are assembled without special tools or dies, due to their considerable size and to increasing system pressures reusable hose fittings have been replaced by so called swage fittings in the 1970s.

During the assembly process ferrule, hose material and nipple are symmetrical deformed in a hydraulic production press by a set of dies creating the best possible connection between the reinforced hose material and the metal fittings.

The subsequent picture reveals a two-pieced connection type with skived upper cover:

The current final step of technical innovation are fittings with a pull-out or tear-out security.

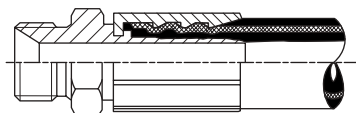

The rubber from the external skiving inner tube is to be removed down to a certain length for assembly preparation. These so called interlock fittings have become state-of-the-art regarding high pressure fitting types and have been designed for multi-spiral hoses with frequent high-pressure applications. Within the range of a tear-out prevention the form-fit connection is enlarged to a certain degree in order to establish an additional protection against failure as shown below:

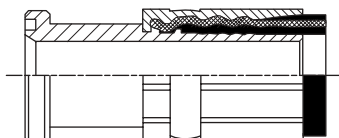

# Technical Information

## HANSA-FLEX Hose Connections

### 1.3 Threads and sealings of hydraulic fittings

As the distinction and determination of hydraulic hose fittings is often difficult to handle due to the sheer variety of fittings we would like to give a general guidance for the identification of the most common fitting types.

The sealing and the reception of the working pressure occur via the surface of a standardised sealing cone or with the support of an additional elastomer seal except fittings with tapered threads.

It is possible to clearly identify every type i.e. metric, BSP- or SAE-fittings by the characteristic shape, sealing cones and the allocated thread i.e. through the nominal flange size pertinent to yard goods.

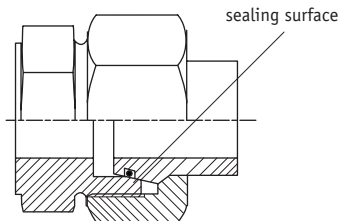

The HANSA-FLEX product range comprises the following fitting types:

- metric 24° cones according to DIN 3865 (DKOL / DKOS and CEL / CES respectively)
- metric fittings according to DIN 3868 (DKL and DKS universal style)
- 24° French type fittings (DKF)
- 60° fittings according to DIN 3863 (DKM)
- 74° fittings according to SAE J514 and ISO 8434-2
- flat face fittings (metric, BSP and ORFS)
- fittings with tapered threads (metric, NPTF and BSP)
- 60° BSP type fittings
- SAE flange fittings
- radial sealing rings with axial operating ratio
- connection for hollow bolts (ring nipple)
- press nipple bulkhead (light, heavy and French series)

## Technical Information

### HANSA-FLEX Hose Connections

#### 1.3.1 Metric fittings with 24° cones

This type is one of the most commonly used fitting types in Western Europe. It is compatible with the hydraulic precision tube fittings manufactured according to DIN 2353 and DIN EN ISO 8434-1 and has an extra O-ring for improved sealing:

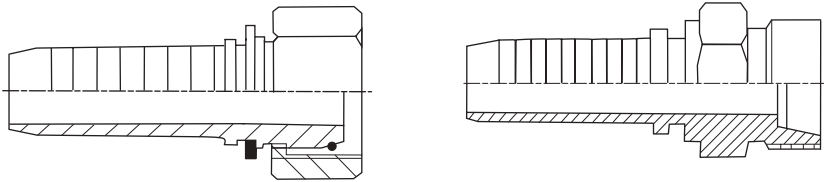



They have two main characteristics:

1. 24° metric fittings are divided into two different classes or series: the light and the heavy series. The maximum allowable working pressure does not only depend on the nominal size, each series is also allocated to a certain pressure range e.g. the heavy series is generally suitable for higher working pressures whereas the light series are used for applications with lower pressures. The light and heavy series also differ in size.
2. As these metric hose fittings are compatible with metric tube fittings each nominal size is allocated to a certain pressure range and external tube diameter. The respective metric thread is defined in the relevant industrial standards e.g. DIN 20066 and DIN 20078.

24°-fittings have metric cylindric fine threads with a 60° thread angle and are manufactured with medium tolerances according to DIN 13, section 15. The table below shows the most important characteristics of these hose fittings:.

# Technical Information

## HANSA-FLEX Hose Connections

Nominal hose size		HANSA-FLEX fitting type					
DN	Dash size	Swivel nut	male stud	series	thread	allocated tube O.D.	max. working pressure
							
04	3	PN 04 AOL	PN 04 HL	Leicht	M 12 x 1,5	06	250 bar
06	4	PN 06 AOL	PN 06 HL	Leicht	M 14 x 1,5	08	250 bar
08	5	PN 08 AOL	PN 08 HL	Leicht	M 16 x 1,5	10	250 bar
10	6	PN 10 AOL	PN 10 HL	Leicht	M 18 x 1,5	12	250 bar
13	8	PN 13 AOL	PN 13 HL	Leicht	M 22 x 1,5	15	250 bar
16	10	PN 16 AOL	PN 16 HL	Leicht	M 26 x 1,5	18	160 bar
20	12	PN 20 AOL	PN 20 HL	Leicht	M 30 x 2	22	160 bar
25	16	PN 25 AOL	PN 25 HL	Leicht	M 36 x 2	28	100 bar
32	20	PN 32 AOL	PN 32 HL	Leicht	M 45 x 2	35	100 bar
40	24	PN 40 AOL	PN 40 HL	Leicht	M 52 x 2	42	100 bar
04	3	PN 04 AOS	PN 04 HS	Schwer	M 16 x 1,5	08	630 bar
06	4	PN 06 AOS	PN 06 HS	Schwer	M 18 x 1,5	10	630 bar
08	5	PN 08 AOS	PN 08 HS	Schwer	M 20 x 1,5	12	630 bar
10	6	PN 10 AOS	PN 10 HS	Schwer	M 22 x 1,5	14	630 bar
13	8	PN 13 AOS	PN 13 HS	Schwer	M 24 x 1,5	16	400 bar
16	10	PN 16 AOS	PN 16 HS	Schwer	M 30 x 2	20	400 bar
20	12	PN 20 AOS	PN 20 HS	Schwer	M 36 x 2	25	400 bar
25	16	PN 25 AOS	PN 25 HS	Schwer	M 42 x 2	30	250 bar
32	20	PN 32 AOS	PN 32 HS	Schwer	M 52 x 2	38	250 bar

Please notice the following terms related to HANSA-FLEX PN...AOL, PN...AOS, PN...HL and PN...HS fitting types:

- These fittings are also known for their usual market designations:

HANSA-FLEX designation	market designation
PN...AOL	DKOL
PN...AOS	DKOS
PN...HL	AGL / CEL
PN...HS	AGS / CES

## Technical Information

### HANSA-FLEX Hose Connections

45° and 90° elbow fittings are designated by adding the number 45 or 90 to the HANSA-FLEX code. The comparison between the HANSA-FLEX notation and the DIN norm is further displayed in the chapter "Hose fittings- technical information"

– The connection for fittings with external threads or hydraulic tube (compression) fittings are also known as port end W according to DIN 3861. The main dimensions are given in DIN EN ISO 8434-1:

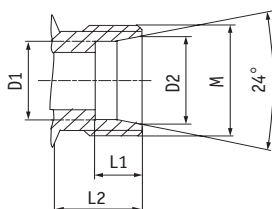

Series	tube O.D.	M	L1	L2	D1	D2
L	6	M 12x1,5	7	10	6	8,1
L	8	M 14x1,5	7	10	8	10,1
L	10	M 16x1,5	7	11	10	12,3
L	12	M 18x1,5	7	11	12	14,3
L	15	M 22x1,5	7	12	15	17,3
L	18	M 26x1,5	7,5	12	18	20,3
L	22	M 30x2	7,5	14	22	24,3
L	28	M 35x2	7,5	14	28	30,3
L	35	M 45x2	10,5	16	35,3	38
L	42	M 52x2	11	16	42,3	45
S	6	M 14x1,5	7	12	6	8,1
S	8	M 16x1,5	7	12	8	10,1
S	10	M 18x1,5	7,5	12	10	12,3
S	12	M 20x1,5	7,5	12	12	14,3
S	14	M 22x1,5	8	14	14	16,3
S	16	M 24x1,5	8,5	14	16	18,3
S	20	M 30x2	10,5	16	20	22,9
S	25	M 36x2	12	18	25	27,9
S	30	M 42x2	13,5	20	30	33
S	38	M 52x2	16	22	38,3	41

## Technical Information

# HANSA-FLEX Hose Connections

**The following industrial standards are currently considered important:**

DIN 3861	Non-soldering compression fittings; Taper bush; Design and type of port end W
DIN 3865	Compression fittings; Nipple 24° with O-ring, for type of port end W DIN 3861
DIN 20066	Fluid power; hose assemblies; dimensions, requirements
DIN 20078-1	Fluid power; hose fittings; requirements, assembling instructions, test methods
DIN 20078-4	Fluid power; hose fitting male stud, type D, light series (L), dimensions
DIN 20078-5	Fluid power; hose fitting male stud, type E, heavy series (S), dimensions
DIN 20078-8	Fluid power; hose fitting swivel female with O-ring, type N, light series (L), dimensions
DIN 20078-9	Fluid power; hose fitting swivel female with O-ring, type P, heavy series (S), dimensions

### **1.3.2 Metric universal swivel female hose fittings according to DIN 20078, type A**

The HANSA-FLEX PN...AFL and PN...AFS fitting series also have the common designation DKL and DKS. These fittings can easily be distinguished from the afore mentioned metric fittings as they do not have an extra O-ring for sealing purposes.

Just like the O-ring fittings, these fittings are also divided into the light (PN...AFL) and heavy (PN...AFS) series and have the same threads and spanner sizes.

They are fully compatible with the respective metric male studs with port end W according to DIN 3861 and port end Y according to DIN 3863.

Metric fittings manufactured with an extra O-ring have proved to have a superior sealing compared to these standard fittings. Hence we always recommend the first type and advise customers to replace standard fittings for new machine designs.

### **1.3.3 Poclair connectors of the French series**

These connectors which have been developed by the French company Poclair are very similar to the standard metric fittings as they are also machined with 24° ports and metric threads.

The French fittings are not compatible with standard metric fittings as the allocation of the nominal size and thread to the respective tube is completely different from the allocation of the metric fittings.

The HANSA-FLEX French series are divided into two main product groups:

## Technical Information

### HANSA-FLEX Hose Connections

a) Fittings with connecting ports allocated to non-metric tubes. This refers to the HANSA-FLEX PN AF, PN HF and PN FF series:

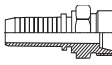
Nominal hose size		HANSA-FLEX fitting type				
DN	Dash size	swivel nut	mal stud	metric thread	standpipe	tube O.D.
						
06	4	PN 06 AF 10	PN 06 HF 10	M 20 x 1,5	–	–
08	5	PN 08 AF 10	PN 08 HF 10	M 20 x 1,5	–	–
10	6	PN 10 AF	PN 10 HF	M 20 x 1,5	PN 10 FF	13,25
13	8	PN 13 AF	PN 13 HF	M 24 x 1,5	PN 13 FF	16,75
16	10	PN 16 AF	PN 16 HF	M 30 x 1,5	PN 16 FF	21,25
20	12	PN 20 AF	PN 20 HF	M 36 x 1,5	PN 20 FF	26,75
25	16	PN 25 AF	PN 25 HF	M 45 x 1,5	PN 25 FF	33,5

b) Fittings with connecting ports allocated to metric tubes. This refers to the HANSA-FLEX PN AFLF, PN AFSF, PN HLF and PN HSF fittings:

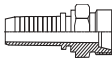
Nominal hose size		HANSA-FLEX fitting type				
DN	Dash size	swivel nut	male stud	metric thread	series	allocated tube O.D.
						
16	10	PN 16 AFLF	PN 16 HLF	M 27 x 1,5	light	18
20	12	PN 20 AFLF	PN 20 HLF	M 30 x 1,5	light	22
25	16	PN 25 AFLF	PN 25 HLF	M 36 x 1,5	light	28
16	10	PN 16 AFSF	PN 16 HSF	M 27 x 1,5	heavy	20
20	12	PN 20 AFSF	PN 20 HSF	M 33 x 1,5	heavy	25
25	16	PN 25 AFSF	PN 25 HSF	M 36 x 1,5	heavy	30

Please notice the following terms related to HANSA-FLEX fittings of the French series:

– The connectors of the French series are also commonly known as BEF, DKF and CEF type fittings.

## Technical Information

### HANSA-FLEX Hose Connections

#### 1.3.4. Metric fittings with 60° cone according to DIN 3863

These fittings also known as the DKM type have been designed for low pressure applications. According to DIN 20066 they are allocated to hydraulic precision tubes of the very light series (LL).

The DKM type fittings with the HANSA-FLEX designation PN...A are not compatible with the metric fittings mentioned in pt. 6 and 7 as they have different threads allocated to the respective nominal size.

The largest available size is DN 60.

Nominal hose size		HANSA-FLEX fitting type	thread
DN	Dash Size		
			
20	12	PN 20 A	M 30 x 1,5
25	16	PN 25 A	M 38 x 1,5
32	20	PN 32 A	M 45 x 1,5
40	24	PN 40 A	M 52 x 1,5
50	32	PN 50 A	M 65 x 2
60	40	PN 60 A	M 78 x 2

#### 1.3.5 37° connector fittings according to SAE J514 and ISO 8434-2

This hose connector type was initially designed in the USA for flared tube ends in the 1950s. These fittings can easily be recognized by their characteristic shape:



The picture below shows the assembly of a straight male stud coupling with a 37° flared tube end. The same connector type is used for hose connectors e.g. HANSA-FLEX hose fittings and tube fittings for 37° tube ends are fully compatible.

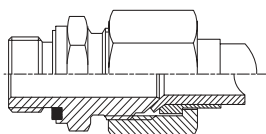

## Technical Information

### HANSA-FLEX Hose Connections

These fittings are known as 37° JIC fittings and also have the common designation AGJ and DKJ. The HANSA-FLEX PN...AJ and PN...HJ fitting series have external and internal threads of the US-American UN / UNF type.

Unlike BSP-threads, these UN / UNF types are machined with a 60° thread angle. They are standardised according to SAE J475 and ISO 725 and are designated as follows:

- 1) specification of major thread diameter. The diameter is given using fractions of an inch i.e. 1".
- 2) pitch to be specified as number of threads per unit of length (per inch).
- 3) Unified fine thread (UNF) to be used for fittings up to DN 16, unified thread (UN) to be used for fittings from DN 20 onwards.
- 4) Thread designations are often completed by adding a specification of the tolerance class.

**Example:** HANSA-FLEX PN 20 HJ hose fitting



The fitting suitable for a DN 20 standard hose is specified with a 1 1/16" – 12 UN – 2A Thread.



The major diameter is 1 1/16" = 26,95 mm.

The number of threads per inch is 12, hence the pitch is 25,4 mm divided by 12 = 2,11 mm.

2A indicates the tolerance class including a surface protection. The tolerance class 2B specifies internal threads only.

# Technical Information

## HANSA-FLEX Hose Connections

Nominal hose size		HANSA-FLEX fitting type					recommended tightening torque(Nm)	
DN	Dash Size	swivel nut	male stud	thread according to DAE J475 and ISO 725	major thread diameter (mm)	minor thread diameter (mm)	min.	max.
								
06	4	PN 06 AJ	PN 06 HJ	7/16"-20 UNF	11,1	9,9	5	15
08	5	PN 08 AJ	PN 08 HJ	1/2"-20 UNF	12,7	11,4	10	20
10	6	PN 10 AJ	PN 10 HJ	9/16"-18 UNF	14,2	12,9	10	35
13	8	PN 13 AJ	PN 13 HJ	3/4"-16 UNF	19,0	17,0	20	50
16	10	PN 16 AJ	PN 16 HJ	7/8"-14 UNF	22,1	20,3	25	80
20	12	PN 20 AJ	PN 20 HJ	1 1/16"-12 UN	26,9	24,9	35	100
25	16	PN 25 AJ	PN 25 HJ	1 5/16"-12 UN	33,3	31,0	50	150
32	20	PN 32 AJ	PN 32 HJ	1 5/8"-12 UN	41,2	39,1	75	230
40	24	PN 40 AJ	PN 40 HJ	1 7/8"-12 UN	47,4	45,5	120	320
50	32	PN 50 AJ	PN 50 HJ	2 1/2"-12 UN	63,5	61,2	160	500

(not on the list)

Please notice the following terms related to HANSA-FLEX PN...AJ and PN...HJ fitting types:

JIC = Joint Industry Conference – SAE = Society of Automotive Engineers

ANSI = American National Standards Institute – ASME = The American Society of Mechanical Engineers

UN = unified thread – UNF = unified fine thread

### 1.3.6. BSP type fittings

Though it was originally designed in the United Kingdom, this fitting type has now also found a wide recognition in other countries.

In this case we distinguish between three different sealing principles:

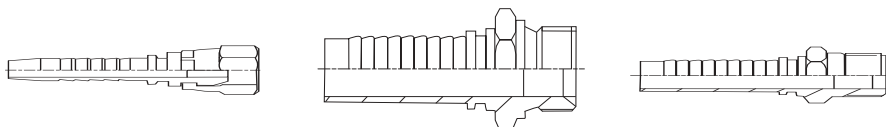

a) HANSA-FLEX hose fittings of the PN...AB and PN...HB series are sealed and connected by a 60° cone. These fittings have a cylindrical BSP-thread and are also known under the common designations DKR and AGR.

b) HANSA-FLEX series of the PN...AR and PN...HR type are flat-faced fittings with the also common



## Technical Information

### HANSA-FLEX Hose Connections

designation AGR-F.

c) The fittings of the PN...HBK series have tapered (BSPT) threads and are also known as AGR-K fittings. The PN...AB hose connectors mentioned under a) have been recently improved with an additional O-ring; they are now also known as DKOR types.

The respective threads standardised according to British Standard BS and ISO 228-1 have a thread angle of 55°, the sealing cones and spanner sizes are manufactured according to BS 5200.

Nominal hose size		HANSA-FLEX fitting type					
DN	Dash Size	swivel nut	male stud	thread according to ISO 228-1	major thread diameter	minor thread diameter	max. working pressure
06	4	PN 06 AB	PN 06 HB	G 1/4	13,1	11,4	775 bar
							
10	6	PN 10 AB	PN 10 HB	G 3/8	16,6	14,9	690 bar
13	8	PN 13 AB	PN 13 HB	G 1/2	20,9	18,6	515 bar
16	10	PN 16 AB	PN 16 HB	G 5/8	22,9	20,5	480 bar
20	12	PN 20 AB	PN 20 HB	G 3/4	26,4	24,1	430 bar
25	16	PN 25 AB	PN 25 HB	G 1	33,2	30,2	345 bar
32	20	PN 32 AB	PN 32 HB	G 1 1/4	41,9	38,9	345 bar
40	24	PN 40 AB	PN 40 HB	G 1 1/2	47,8	44,8	345 bar
50	32	PN 50 AB	PN 50 HB	G 2	59,6	56,6	345 bar

The table does not allocate a nominal size DN08 to the respective thread. We would like to make clear that for technical reasons such an allocation has not been developed. Suitable fittings with jump sizes such as PN 08 AB 10 or PN 08 AB 06 are used for the assembly of hoses in DN 08.

Please notice the following terms related to HANSA-FLEX PN...AB, PN...AR, PN...HB and PN...HBK fitting types:

- BSP = British Standard Pipe Thread.
- BSPT = British Standard Pipe Thread Tapered.
- Tolerance classes are designated by adding the letter P. Example:  
 BSP-P = cylindric pipe thread, fine thread  
 BSP-PP = cylindric pipe thread, extra fine thread

# Technical Information

## HANSA-FLEX Hose Connections

### 1.3.7. ORFS-fittings according to ISO 8434-3 and SAE J1453

Originally designed for tube fittings hose assemblies with ORFS-fittings can often be found mounted on civil engineering machinery.

The name ORFS already describes the sealing principle = O-Ring Face Seal.

Fittings with ORFS connections are always flat sealing



These fittings are only available with swivel nut and UN/UNF - UNS thread. The respective adapters with external threads have the HANSA-FLEX designation HJOF e.g. K HJOF 16 with 1 7/16-12 UN thread.

Nominal hose size		HANSA-FLEX fitting type				
DN	Dash Size	swivel nut	thread according to ISO 725	major thread diameter	minor thread diameter	recommended tightening torque (Nm)
						
06	4	PN 06 AJF	9/16"-18 UNF	14,2	12,9	15
10	6	PN 10 AJF	11/16"-16 UN	17,5	16,0	26
13	8	PN 13 AJF	13/16"-16 UN	20,8	19,0	45
16	10	PN 16 AJF	1"-14 UNS	25,4	23,6	65
20	12	PN 20 AJF	1 3/16"-12 UN	30,2	28,1	92
25	16	PN 25 AJF	1 7/16"-12 UN	36,5	34,5	130
32	20	PN 32 AJF	1 11/16"-12 UN	42,9	40,8	180
40	24	PN 40 AJF	2"-12 UN	50,8	48,7	215

The table does not allocate a nominal size DN08 to the respective thread. We would like to make clear that for technical reasons such an allocation has not been developed. Suitable fittings with jump sizes such as PN 06 AJF 10 or PN 08 AJF 10 are used for the assembly of hoses in DN 08.

Please notice the following terms related to HANSA-FLEX PN...AJF fitting types:

- UN thread = unified thread
- UNF thread = unified fine thread
- UNS thread = unified thread with special pitch

# Technical Information

## HANSA-FLEX Hose Connections

### 1.3.8. US-American NPT- and NPSM Connectors

Hose connectors with American NPT- thread are can be found in many countries outside the USA. Originally designed for high-pressure applications, these fittings can easily be recognized by their characteristic shape:

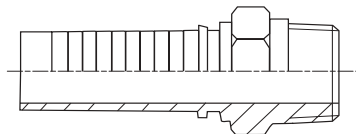

This connector is also commonly known as AGN type, the tapered threads are manufactured according ANSI/ASME B1.20.1-1983 with a thread angle of 60° and a tapering ratio of 1:16.

Designations are similar to UN/UNF-threads. Example: 3/4 - 14 NPT

The thread size is allocated to a hydraulic tube with an external diameter of 3/4".

The number of threads per inch is 14, hence the pitch is 25,4 mm divided by 14 = 1,8 mm.

The female connectors of this series are equipped with thrust wired swivel nuts machined with NPSM-threads. These fittings have cylindric threads sealed by a 30° cone.

NPSM threads have the same designation as NPT threads: 3/8-18 NPSM

The number of threads per inch is 18, hence the pitch is 25,4 mm divided by 18 = 1,4 mm.

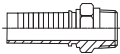
Nominal hose size		HANSA-FLEX fitting type			HANSA-FLEX fitting type		
DN	Dash Size	male stud 	thread according to ANSI/ASME	major diameter (mm)	thrust wire nut	thread according to ANSI/ASME	minor diameter (mm)
06	4	PN 06 HN	1/4 - 18 NPT	13,7	PN 06 AN	1/4 - 18 NPSM	12,4
10	6	PN 10 HN	3/8 - 18 NPT	17,1	PN 10 AN	3/8 - 18 NPSM	16,0
13	8	PN 13 HN	1/2 - 14 NPT	21,3	PN 13 AN	1/2 - 14 NPSM	19,5
20	12	PN 20 HN	3/4 - 14 NPT	26,6	PN 20 AN	3/4 - 14 NPSM	24,8
25	16	PN 25 HN	1 - 11 1/2 NPT	33,4	PN 25 AN	1 - 11 1/2 NPSM	31,4
32	20	PN 32 HN	1 1/4 - 11 1/2 NPT	42,1	-	-	-
40	24	PN 40 HN	1 1/2 - 11 1/2 NPT	48,2	-	-	-
50	32	PN 50 HN	2 - 11 1/2 NPT	60,3	-	-	-

The table does not allocate the nominal sizes DN 08 and DN 16 to the respective threads. We would like to make clear that for technical reasons such an allocation has not been developed. Suitable fittings with jump sizes such as PN 08 HN 06 or PN 16 HN 13 are used for the assembly of hoses in DN 08 and DN 16.

## Technical Information

### HANSA-FLEX Hose Connections

Please notice the following terms related to HANSA-FLEX PN...HN fitting types:

NPT = National Standard Taper Pipe Thread – NPSM = National Pipe Straight Mechanical Thread

ANSI = American National Standards Institute – ASME = The American Society of Mechanical Engineers

#### 1.3.9 Standpipe hose fittings: light, heavy and French series

This fitting type has almost vanished from the market and been replaced by metric swivel nut fittings. Standpipe hose fittings however are still used as spare parts for agricultural machines.



The assembly is carried out in the same way as the assembly of tube fittings with cutting rings.

The tightened swivel nut has moved the cutting ring in axial direction towards the standardised 24° cone thus creating a sealing cone which exactly fits into metric tube and hose fittings.

This movement which is exactly defined by the geometric shape causes the cutting edges to bite into the tube surface, leading to a firm tube clamping.

The right assembly will be recognised by a visible collar of cut tube material which is solidified by this cold forming process.

HANSA-FLEX PN...FF French fitting types look exactly like these metric fittings, they can be distinguished by the different allocated tube diameters.

Nominal hose size		HANSA-FLEX fitting type			
DN	Dash Size	light series	tube O.D.	heavy series	tube O.D.
06	4	PN 06 FL	8	PN 06 FS	10
08	5	PN 08 FL	10	PN 08 FS	12
10	6	PN 10 FL	12	PN 10 FS	14
13	8	PN 13 FL	15	PN 13 FS	16
16	10	PN 16 FL	18	PN 16 FS	20
20	12	PN 20 FL	22	PN 20 FS	25
25	16	PN 25 FL	28	PN 25 FS	30
32	20	PN 32 FL	35	PN 32 FS	38
40	24	PN 40 FL	42		

## Technical Information

### HANSA-FLEX Hose Connections

Please note that HANSA-FLEX PN...FF French fitting types can only be assembled with the respective cutting rings and swivel nuts:

<b>Nominal hose size</b>			
<b>DN</b>	<b>Dash size</b>	<b>fitting type</b>	<b>tube O.D.</b>
10	6	PN 10 FF	13,25
13	8	PN 13 FF	16,75
16	10	PN 16 FF	21,25
20	12	PN 20 FF	26,75
25	16	PN 25 FF	33,5

Please notice the following terms related to HANSA-FLEX PN...FL, PN...FS and PN...FF fitting types:

- The HANSA-FLEX PN...FL and PN...FS fittings are also commonly known as BEL and BES fitting types.
- Jump sizes are available for metric fittings.
- The French types are also commonly known as BEF fittings.

#### 1.3.10 Ring nipple - banjo fittings

These HANSA-FLEX hose connectors are often used for applications which require fittings with small dimensions.

The fittings have two parallel sealing surfaces and can easily be recognized by their characteristic shape:

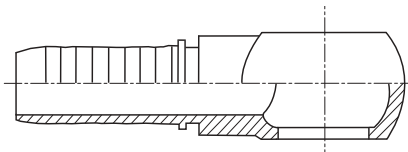

Banjo fittings are manufactured according to DIN 7642 and are available both for metric and BSP-type banjo bolts standardised according to DIN 7643.

These hose fittings are produced either in one-piece or soldered version, according to the manufacturer's specification. Jump sizes are also available

## Technical Information

### HANSA-FLEX Hose Connections

Nominal hose size		HANSA-FLEX fitting type			
DN	Dash size	PN...B	banjo bolt	PN...BR	banjo bolt
06	4	PN 06 B	M 12x1,5	PN 06 BR	G 1/4"
08	5	PN 08 B	M 14x1,5	—	—
10	6	PN 10 B	M 16x1,5	PN 10 BR	G 3/8"
13	8	PN 13 B	M 18x1,5	PN 13 BR	G 1/2"
16	10	PN 16 B	M 22x1,5	PN 16 BR	G 5/8"
20	12	PN 20 B	M 26x1,5	PN 20 BR	G 3/4"
25	16	PN 25 B	M 30x2	PN 25 BR	G 1"

Please notice the following terms related to HANSA-FLEX PN...B and PN...BR fitting types:

- These connectors are also commonly known as RGN fitting types.
- The HANSA-FLEX PN...B and PN...BR series are only available for textile braided and one or two wire braid hoses.

#### 1.3.11 Compact elbow fittings

These connectors were initially developed for applications which also require fittings with small overall dimensions.

The compact elbow fittings are available with the BSP and JIC swivel nuts and ports mentioned before, for special requirements jump sizes and 45° fittings are also manufactured.

Hose fittings in DN08 are delivered in jump sizes only.

Nominal hose size			
DN	Dash size	PN...ABK 90 / 45	thread type
06	4	PN 06 ABK 90	G 1/4
10	6	PN 10 ABK 90	G 3/8
13	8	PN 13 ABK 90	G 1/2
20	12	PN 20 ABK 90	G 3/4

## Technical Information

### HANSA-FLEX Hose Connections

#### 1.3.12 Flange fittings

*This fitting type was initially developed for high pressure applications such as the connection of hydraulic pumps to a system.*

*HANSA-FLEX connectors are delivered as single fittings (nipple only) using the designation PN...SF while as PA...SF fittings are used for multi-spiral hoses. The PA...SF fitting designation comprises both the respective nipple and ferrule.*

*SF fitting types are mounted using either split flange or solid flange clamps.*

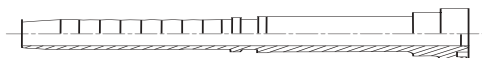

*Three different types of flange fittings are manufactured: there are straight, 45° and 90° elbow connectors which may also vary in terms of the overall height, fittings with special angles i.e. 60° are also machined for customer requirements.*

*Flange fittings were initially designed in the USA and are characterised by two pressure ratings, 3000 and 6000 psi.*

*HANSA-FLEX fittings are designated by adding the number 6 and 9 to the respective code indicating the pressure rate. Fittings with no indication are rated 3000 psi, number 6 indicates a 6000 psi fitting.*

*Those fittings designated with the number 9 (PA...SF9, PA...SF9 45, PA...SF9 90) are also known as CAT-fittings as they were designed by Caterpillar USA. This flange type has been allocated to a 6000 psi pressure rate and can be distinguished from standard 6000 psi flanges by the overall height of the flange head.*

*The Japanese manufacturer Komatsu has also designed flange fittings, they are designated by the HANSA-FLEX code PA...SFK.*

*The design of HANSA-FLEX flange fittings is currently covered by the following industrial standards:*

- a) SAE J518
- b) ISO/DIS 6161-1 and -2 for 3000 and 6000 psi flanges
- c) E DIN ISO 12151-3, type L and S for 3000 and 6000 psi flanges
- d) DIN 20078 part 10, form R and part 12, form S
- e) DIN 20066 for the main fitting dimensions

# Technical Information

## HANSA-FLEX Hose Connections

Chart: 3000 und 6000 psi-standard flange fittings

Nominal hose size	fitting: 3000 psi port (SF)			recommended maximum allowable working pressure*	fitting: 6000 psi port (SF6)			recommended maximum allowable working pressure*
	connecting nominal size	flange port diameter	height of flange head		connecting nominal size	flange port diameter	height of flange head	
13	1/2"	30,2	6,7	5000 psi / 345 bar	1/2"	31,7	6000 psi / 414 bar	7,7
20	3/4"	38,1	6,7	5000 psi / 345 bar	3/4"	41,3	6000 psi / 414 bar	8,7
25	1"	44,4	8,0	5000 psi / 345 bar	1"	47,6	6000 psi / 414 bar	9,5
32	1 1/4"	50,8	8,0	4000 psi / 276 bar	1 1/4"	54,0	6000 psi / 414 bar	10,3
40	1 1/2"	60,3	8,0	3000 psi / 207 bar	1 1/2"	63,5	6000 psi / 414 bar	12,6
50	2"	71,4	9,5	3000 psi / 207 bar	2"	79,4	6000 psi / 414 bar	12,6

\* pressure ratings recommended by American SAE J518

Chart: Main dimensions of SF9 (Caterpillar) and Komatsu SFK-flanges

Nominal hose size	fitting: 9000 psi port (SF9)			fitting: Komatsu flange port		
	connecting nominal size	flange port diameter	height of flange head	connecting nominal size	flange port diameter	height of flange head
13	1/2"	31,7	7,7	1/2"	34,0	8,1
16	5/8"	-	-	5/8"	34,0	8,1
20	3/4"	41,3	14,0	5/8"	-	-
25	1"	47,6	14,0	1"	-	-
32	1 1/4"	54,0	14,0	1 1/4"	-	-
40	1 1/2"	63,5	14,0	1 1/2"	-	-
50	2"	79,4	14,0	2"	-	-

### Sealing:

Please note that 3000 and 6000 psi fittings are assembled using the same type of O-ring sealings.

### Standard elastomer:

O-rings are manufactured from nitrile-butadiene-rubber NBR with a temperature range of -35° to max. +100° Celsius. For applications which require a higher temperature resistance we recommend sealings made of fluor-carbon-rubber FPM (Viton®) with a temperature range of -25°C to max. +200° Celsius.

## Technical Information

### HANSA-FLEX Hose Connections

**Chart: O-ring seals for SAE-type flange fittings**

Nominal hose size	fitting:	flange port acc. SAE J518 (SF and SF6)	
		connecting nominal size	standard-O-ring
DN 13	1/2"	18,64 x 3,53	17 x 25,4 x 2,85
20	3/4"	24,99 x 3,53	23,4 x 31,8 x 2,85
25	1"	32,92 x 3,53	31,3 x 39,7 x 2,85
32	1 1/4"	37,69 x 3,53	36,1 x 44,5 x 2,85
40	1 1/2"	47,22 x 3,53	45,4 x 53,8 x 2,85
50	2"	56,74 x 3,53	55 x 63,4 x 2,85
60	2 1/2"	69,45 x 3,53	—
75	3"	85,32 x 3,53	—
80	3 1/2"	98,02 x 3,53	—

#### **Fitting assembly:**

Flange fittings can be assembled using either split flange clamps or solid clamps. Charts displaying the main dimensions of these flange clamps can be found in the fitting section of this catalogue.

Please notice the following terms related to HANSA-FLEX flange fittings:

- SAE flange connectors are also commonly known as SFL or type 61 (3000 psi) and SFS or type 62 (6000 psi) fittings. On customer order frequently the abbreviations type 61 for a 3000 psi flange (respectively type 62 for a 6000 psi flange) are stated.
- The relevant standards such as SAE J518 do not allocate 3000 and 6000 psi flange ports to the nominal hose size DN16 (5/8"). For technical reasons such an allocation has not been developed. DN 16 hydraulic hoses are assembled using fittings with respective jump sizes.
- Please note that the 3000 and 6000 psi designations are used for classification purposes. They do not necessarily indicate the maximum allowable working pressure.

# Technical Information

## HANSA-FLEX Hose Connections

### 1.3.13 Fittings with 60° cone and metric thread

The HANSA-FLEX connectors of the PN...ALI series were initially designed by the Japanese manufacturer as spare parts for Komatsu machines. Compared to JIC or BSP type fittings these connectors have only a rather low market share as they are only suitable for Komatsu hydraulic systems.

PN...ALI type fittings can easily be recognized by a metric thread swivel nut and a 60° tapered port.

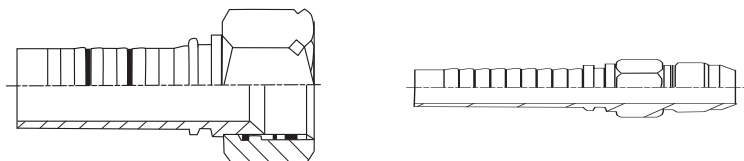

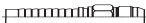
Nominal hose size		HANSA-FLEX Armaturetyp			
DN	Dash size	swivel nut	metric female thread	Male thread	Metric thread
					
06	4	PN 06 ALI	M 14x1,5		
08	5	PN 08 ALI	M 16x1,5		
10	6	PN 10 ALI	M 18x1,5	PN 10 HJL	M 18x1,5
13	8	PN 13 ALI	M 22x1,5	PN 13 HJL	M 22x1,5
16	10	PN 16 ALI	M 24x1,5	PN 16 HJL	M 24x1,5
20	12	PN 20 ALI	M 30x1,5	PN 20 HJL	M 30x1,5
25	16	PN 25 ALI	M 33x1,5	PN 25 HJL	M 33x1,5
32	20	PN 32 ALI	M 36x1,5	PN 32 HJL	M 36x1,5
40	24	PN 40 ALI	M 42x1,5	PN 40 HJL	M 42x1,5

Please notice the following terms related to HANSA-FLEX PN...ALI fittings:

- These connectors are also commonly known as JIS type fittings.
- PN...ALI fittings are not compatible with metric standard fittings

## Technical Information



### HANSA-FLEX Hose Connections

#### 1.3.14 Fitting with 60° cone and BSP thread

The HANSA-FLEX connectors of the PN...ARI series were initially designed by the Japanese manufacturer as spare parts for Toyota machines. Compared to JIC or BSP type fittings these connectors have only a rather low market share as they are only suitable for Toyota hydraulic systems.

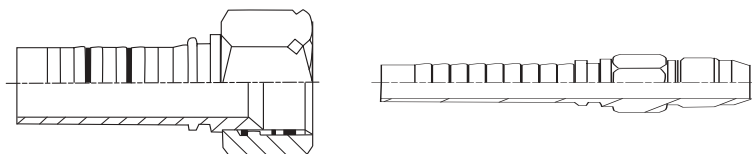
PN...ARI type fittings can easily be recognized by a swivel nut with BSP-thread and a 60° tapered port.



Nominal hose size		HANSA-FLEX fitting type		
DN	Dash size	Swivel nut	Male thread	Thread according to ISO 228-1
				
06	4	PN 06 ARI	PN 06 HJR	G 1/4"
10	6	PN 10 ARI	PN 10 HJR	G 3/8"
13	8	PN 13 ARI	PN 13 HJR	G 1/2"
20	12	PN 20 ARI	PN 20 HJR	G 3/4"
25	16	PN 25 ARI	—	G 1"
32	20	PN 32 ARI	—	G 1 1/4"
40	24	PN 40 ARI	—	G 1 1/2"

Please notice the following terms related to HANSA-FLEX PN...ARI fittings:

- These connectors are also commonly known as JIS type fittings.
- PN...ARI fittings are not compatible with BSP standard fittings.

# Technical Information

## HANSA-FLEX Hose Connections

### 1.4 Hose selection

The HANSA-FLEX product range comprises a variety of hose types manufactured from materials ranging from different rubber elastomers to various plastics and PTFE.

As the range of HANSA-FLEX hose types is outnumbered by the variety of possible applications the following issues have to be considered:

#### 1.4.1 Maximum admissible working pressure

Hose construction and selection are determined by the maximum allowable working pressure, there are applications which require hoses reinforced with either textile or wire braids or even 4 to 6 steel spirals. The HANSA-FLEX product spec-trum comprises hoses with working pressures ranging from 8 bar to very high pressure hoses suitable for 1800 bar.



#### 1.4.2 Nominal size

The internal hose or tube diameter is of considerable importance for the proper function of hydraulic systems. Smaller diameters result in higher fluid velocities while as bigger tube diameters will generally lead to lower fluid velocities.

If a fluid is being pumped through pipes of different internal diameters using the same system pressure and flow rate higher fluid velocities will occur in the smaller pipe.

Friction losses are unavoidable when a fluid is pumped through a pipe, these losses will increase the system temperature and will result in pressure losses thus reducing the overall system performance.

Pressure losses are also caused by fittings, valves, pipe bends and changes in pipe diameter.

Pressure drops depend on various parameters: they are influenced by the pipe length, pipe bore, fluid density, surface roughness of pipe bore, fluid velocity and the type of flow.

## Technical Information

### HANSA-FLEX Hose Connections

Two flow profiles are differentiated:

**Laminar** flow profiles occur when fluids produce a parabolic velocity distribution. Pressure loss hereby is proportional to the velocity.

Laminar flow profile

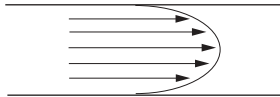

**Turbulent** flow profiles are caused by higher fluid velocities. System efficiency and overall performance are reduced by increased fluid temperatures and pressure drops caused by fluid friction which again is a result of turbulent flows as shown below:

Turbulent flow profile

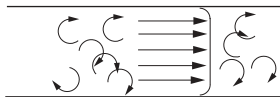

In practice turbulent currents prevail. The correct choice of the conductional nominal size may alter the efficiency of a hydraulic operating system considerably though. With an amendment of the diameter of only 1% the flow resistance increases by 5% (same flowing rate) is applicable.

#### Generell applies:

Turbulent flows are hardly avoidable though the right selection of the fluid pipe bore will effectively influence the overall system efficiency and performance.

The initial investment costs may appear to be inadequately high if the pipe bore of the connectors of a system is selected only slightly bigger than necessary as more material i.e. bigger pipes, port ends, fittings and adapters need to be installed.

On the other hand this selection is an appropriate step towards the reduction of fluid velocities, turbulent flows and the related pressure losses.

It is however also important to point out that bigger pipe bores are also related to lower operating pressures, therefore the determination of the pipe bore or internal hose diameter is important for the function of a system.

#### N.B.:

small pipe bores → high fluid velocities → high operating pressures

big pipe bores → low fluid velocities → lower operating pressures

Determination of a pipe bore using a nomogram

In most cases a design engineer has already determined system parameters like the pump flow rate and the operating pressure. The following chart shows the relation of operating pressures and fluid velocities.

## Technical Information

# HANSA-FLEX Hose Connections

### 1.4.3 Temperatures and environment

Both the expected operating and ambient temperatures must be considered for the selection of a hose assembly: The lifetime of a hose assembly will be shortened considerably if it is subjected to temperatures beyond product specification.

The elastomer blends of HANSA-FLEX hydraulic standard hoses are designed for constant operating temperature ranges from  $-40^{\circ}\text{C}$  to max.  $120^{\circ}\text{C}$  Celsius.

Elastomer blends become brittle at very low temperatures. Elastomers can no longer be subjected to elastic deformations if a certain temperature has been reached, the material will become brittle like porcelain and break if mechanical stresses are applied.

A hose assembly destroyed by the operation under very low temperatures can easily be recognized by fine radial cracks on the outside of the hose wall:

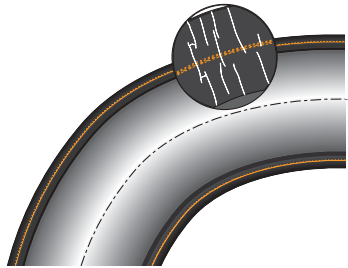

High temperatures beyond product specification will also reduce the product lifetime as these temperatures will lead to a premature ageing of the elastomer blend. The HANSA-FLEX product range, however, also comprises hose types suitable for temperatures outside the standard range.

It should also be noted that elastomer blends used for hydraulic hoses are also prone to environmental pollutions such as ozone or intensive UV-radiation which will severely reduce the material elasticity over a longer period of time.

Again the hose material will become brittle and break when subjected to mechanical stresses.

These hose assemblies can be easily recognized by radial cover cracks on the outside of hose bends.

Once a hose cover has been affected by these cracks it can no longer protect the wire braid reinforcement from humidity which will lead to a premature failure of the assembly.

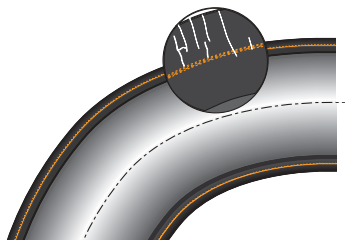

## Technical Information

### HANSA-FLEX Hose Connections

**Please note:** electric welding will produce high concentrations of ozone, proper air ventilation should be installed when weldings are carried out close to rubber hoses. We also advise to shield hose assemblies from intensive UV-radiation caused by electric welding.

Ozone concentrations are also caused by carbon brush sets of electric engines.

The HANSA-FLEX product range also includes hoses with special ozone resistant cover blends.

#### 1.4.4 Fluid compatibility

It is important that the resistance of hose and fitting material against the conveyed medium is checked before the assembly is used.

It is not always possible to predict the compatibility as HANSA-FLEX hose assemblies are used for numerous liquid and gaseous mediums.

Information taken from chemical resistance charts can only be a rough guideline for a hose preselection. We advise to carry out tests for clear results.

HANSA-FLEX standard hoses are manufactured from the following rubber elastomers and plastics:

HANSA-FLEX hose type	hose tube material	material properties
HD100, HD200, TE100 to TE300, SG-, MD-, GC-hoses	Nitrile-Butadene-Rubber NBR	standard-elastomer for sealings and hoses. <b>Temperature range:</b> -40°C bis +100° Celsius for constant operation. <b>Recommended fluids:</b> mineral oil, rape seed oil, polyglycol base oil, synthetic esther base oil, water/oil emulsions and water. Also suitable for biologically degradable hydraulic fluids.
HD400, HD500, HD600 and HD700	Chloroprene-Rubber CR  for constant operation.	standard-elastomer for multi-spiral high pressure hoses. Harder than NBR. <b>Temperature range:</b> -40°C to max. +120° Celsius <b>Recommended fluids:</b> mineral oil, water, glycol, mineral oil/water emulsions.
NY300, NY400, TAF- and TBF-hoses	Polyamid PA	Good resistance against numerous fluids. Low effusion rates when subjected to gaseous medium. <b>Temperature range:</b> -40°C bis +100° Celsius for constant operation.

## Technical Information

### HANSA-FLEX Hose Connections

<b>HANSA-FLEX hose type</b>	<b>hose tube material</b>	<b>material properties</b>
TF100 and TF200	Polytetrafluor-Ethylene PTFE	Excellent resistance against numerous aggressive medium. <b>Temperature range:</b> –60°C to max. +205° Celsius. Pressure reductions must be considered for higher temperatures.*
NY100, NY700	Polyester-Elastomer	low-cost material for standard plastic hoses. <b>Temperature range</b> –40°C to max. +100° Celsius.
HD100T and HD200T	chlorine sulphurised Polyethylene CSM	High performance elastomer, long lasting and durable, wide fluid compatibility. <b>Temperature range:</b> –55°C to max. +150° Celsius for constant operation.  Recommended fluids: mineral oil, water/oilemulSIONS and water-/glycol solutions up to 120° Celsius.

\* The following correction factors must be considered if PTFE hose assemblies are subjected to higher operation temperatures:

<b>Temperature range</b>	–60° to 100° C	100° to 150° C	150° to 200° C	200° to 260° C
<b>Correction factor</b>	1,0	0,95	0,85	0,75

#### 1.4.5 Fitting selection

HANSA-FLEX hose fittings are manufactured from carbon steel 9SMnPb28K according to DIN 1651, material-No. 1.0718. Fitting surfaces are protected by a layer of yellow-plated galvanised zinc according to DIN/ISO 4042.

For special applications we recommend our stainless steel fittings made of non-corrosive, austenitic steel X6 CrNiMoTi 17 12 2, material-No. 1.4571.

This material is also commonly known as V4A standard material for the chemical industry.

We also advise our customers that the maximum allowable working pressure of the fittings must correspond to the pressure of the hose.

A wrong selection i.e. a high pressure SAE 100R15 hose assembled with metric fittings of the light series may cause assembly failures and severe injuries.

The present edition of DIN 20066 prescribes that for pressure-technical calculations of the hose line the admissible pressure values of hose and armature form the basis whereas the low value may only be regarded as an assessment basis.

# Technical Information

## HANSA-FLEX Hose Connections

### 1.4.6 Hose selection chart

hose type	maximum working pressure in bar/ admissible bending radius in mm												Temperature range in °Celsius	DIN/EN	SAE
	Size	3	4	5	6	8	10	12	16	20	24	32			
DN	05	06	08	10	13	16	20	25	32	40	50				
TF 100	275/ 50	230/ 76	207/ 101	183/ 127	161/ 152	110/ 178	103/ 203	80/ 305					-60/+260		
TF 200		250/ 76	230/ 102	207/ 127	183/ 152	138/ 178	126/ 203	103/ 305					-60/+260		
ND 100		21/ 75	21/ 75	21/ 125									-40/+100		SAE 100 R6
ND 300		28/ 64	28/ 76	28/ 102	24/ 127	21/ 140	21/ 152						-40/+125		SAE 100 R6
TE 100	25/ 35	25/ 45	20/ 65	20/ 75	16/ 90	16/ 115	12/ 135	12/ 165					-40/+100	EN 854-1TE	
TE 200	80/ 35	75/ 40	68/ 50	63/ 60	58/ 70	50/ 90	45/ 110	40/ 150	35/ 190				-40/+100	EN 854-2TE	
TE 300	160/ 40	145/ 45	130/ 55	110/ 70	93/ 85	80/ 105	70/ 130	55/ 150	45/ 190	40/ 240	33/ 300		-40/+100	EN 854-3TE	
MD 100	207/ 76	207/ 86	155/ 102	138/ 117	121/ 140	130/ 165	55/ 187	43/ 229	34/ 267	24/ 337			-40/+135		SAE 100 R5
MD 200	207/ 75	207/ 85	155/ 100	138/ 120	120/ 140	103/ 165	55/ 185	43/ 230	35/ 265	24/ 335			-40/+100		SAE 100 R5
MD 800							56/ 190	44/ 230	35/ 270				-40/+150		SAE 100 R5
KP 100		225/ 50	215/ 55	180/ 60	160/ 70	130/ 90	105/ 100	88/ 160					-40/+100	EN 857-1SC	
KP 200		400/ 45	350/ 55	330/ 65	275/ 80	250/ 90	215/ 120	165/ 160					-40/+100	EN 857-2SC	
HD 100		225/ 100	215/ 110	180/ 130	160/ 180	130/ 200	105/ 240	88/ 300	63/ 420	50/ 500	40/ 630		-40/+100	EN 853-1SN	SAE 100 R1AT
HD 100A		225/ 100	215/ 115	180/ 130	160/ 180	130/ 200	105/ 240	88/ 300	63/ 420	50/ 500	40/ 630		-40/+100	EN 853-1ST	SAE 100 R1A
HD 100T		225/ 100	215/ 115	180/ 130	160/ 180	130/ 200	105/ 240	88/ 300					-55/+150		
HD 200	415/ 90	400/ 100	350/ 115	330/ 130	275/ 180	250/ 200	215/ 240	165/ 300	125/ 420	90/ 500	80/ 630		-40/+100	EN 853-2SN	SAE 100 R2AT
HD 200A		400/ 100	350/ 115	330/ 130	275/ 180	250/ 200	215/ 240	165/ 300	125/ 420	90/ 500	80/ 630		-40/+100	EN 853-2ST	SAE 100 R2A
HD 200T		400/ 100	350/ 115	330/ 130	275/ 180	250/ 200	215/ 240	165/ 300	125/ 420	90/ 500	80/ 630		-55/+150		

# Technical Information

## HANSA-FLEX Hose Connections

hose type	maximum working pressure in bar/ admissible bending radius in mm											Temperature range in °Celsius	DIN/EN	SAE		
	Size	3	4	5	6	8	10	12	16	20	24				32	
	DN	05	06	08	10	13	16	20	25	32	40	50				
HD 400		450/ 150		445/ 180	415/ 230	350/ 250	350/ 300	280/ 340						-40/+100	EN 856-4SP	
HD 500							420/ 280	380/ 340	325/ 460	290/ 560	250/ 700			-40/+100	EN 856-4SH	
HD 600											345/ 635			-40/+120	EN 853-R13	SAE 100 R13
HD 700							420/ 267	420/ 267	420/ 267	420/ 315	420/ 600			-40/+120		SAE 100 R15
HDB 200*		400/ 100	350/ 115	330/ 130	275/ 180	250/ 200	215/ 240	165/ 300	125/ 420	90/ 500	80/ 630			-40/+100	EN 853-2ST	SAE 100 R2A
KPB 200*		400/ 45	350/ 55	330/ 65	275/ 80	250/ 90	215/ 120	165/ 160						-40/+100	EN 857-2SC	
HDB 400*		450/ 150		445/ 180	415/ 230	350/ 250	350/ 300	280/ 340						-40/+100	EN 856-4SP	
HDB 500*							420/ 280	380/ 340	325/ 460	290/ 560	250/ 700			-40/+100	EN 856-4SH	
NY 700		210/ 75	215/ 100	190/ 115	160/ 125	140/ 175	105/ 200	85/ 240	70/ 300					-40/+100	EN 855-R7	SAE 100 R7
NYZ 700		210/ 75	215/ 100	190/ 115	160/ 125	140/ 175	105/ 200	85/ 240	70/ 300					-40/+100	EN 855-R7	SAE 100 R7
NY 100		300/ 90	300/ 100	225/ 115	225/ 125	180/ 175	140/ 230	125/ 170	100/ 230					-40/+100		
NYZ 100		300/ 90	300/ 100	225/ 115	225/ 125	180/ 175										
NY 300		450/ 70	400/ 100	375/ 120	350/ 165	330/ 200	300/ 240	275/ 280						-40/+100		SAE 100 R9
NY 366		720/ 100												-40/+100		
NY 400		1800/ 130		1500/ 175	1400/ 190	1300/ 200	1000/ 250	900/ 300						-40/+100		
GC 100					25/ 60	15/ 90	15/ 105	15/ 120	15/ 175	10/ 270	10/ 320			-30/+80		
GC 200							15/ 105	15/ 120						-30/+80		
SG 100							20/ 120	17/ 135	14/ 170	10/ 220	7/ 300			-40/+100		SAE 100 R4
SGB 100							10/ 100	10/ 120	10/ 150	10/ 200	10/ 230			-40/+100		

# Technical Information

## HANSA-FLEX Hose Connections

hose type	maximum working pressure in bar/ admissible bending radius in mm											Temperature range in °Celsius	DIN/EN	SAE	
	Size	3	4	5	6	8	10	12	16	20	24				32
	DN	05	06	08	10	13	16	20	25	32	40	50			
HW 100		230/ 100	210/ 114	180/ 127	160/ 178								-10/+155		
HF 100		230/ 100	210/ 114	180/ 127	160/ 178								-10/+155		
HW 200			400/ 114	400/ 127	280/ 178								-10/+155		
HF 200			400/ 114	400/ 127	280/ 178								-10/+155		
TAF 100		370/ 40	255/ 63	225/ 80	190/ 100	160/ 130							-60/+100		
TAFZ 100		370/ 40	255/ 63	225/ 80	190/ 100	160/ 130							-60/+100		
TBF 200		485/ 40	455/ 63	375/ 80	340/ 100	280/ 130	215/ 190						-60/+100		
TBFZ 200		485/ 40	455/ 63	375/ 80	340/ 100	280/ 130	215/ 190						-60/+100		
SI 100		15/ 30	15/ 40	15/ 45	15/ 50	15/ 70							-35/+80	73 379	
SI 200		15/ 30	15/ 40	15/ 45	12/ 50	12/ 70							-35/+80	73 379	

The marked hose types \* have a type approval for the German Mining Industry

# Technical Information

## HANSA-FLEX Hose Connections

### 1.4.7 Industrial Standards

Hoses and hose assemblies are standardised elements of fluid technology. We would like to give a summary of the most common and important standards as the variety of terms and definitions can often be confusing.

The relevant standards can be roughly divided into product standards and guidelines for testing and application.

The currently most important standards are listed below:

<b>Terms</b>	<b>Contents</b>	<b>Edition</b>
<b>HOSES</b>		
EN 853	Rubber hoses and hose assemblies – wire braided reinforced hydraulic type – specification; German version EN 853: 1996	02.97
EN 854	Rubber hoses and hose assemblies – textile reinforced hydraulic type – specification; German version EN 854: 1996	02.97
EN 855	Plastic hoses and hose assemblies – thermoplastic textile reinforced hydraulic type – specification; German version EN 855: 1996	02.97
EN 856	Rubber hoses and hose assemblies – rubber covered spiral wired reinforced hydraulic type – specification; German version EN 856: 1996	02.97
EN 857	Rubber hoses and hose assemblies – wire braided reinforced compact type for hydraulic applications– specification; German version EN 857: 1996	02.97
DIN 20021	Hoses with layer – completion for DIN EN 853 to DIN EN 857	02.97
74310-1	Air braking systems; hoses; dimensions, material marking	12.93
74310-2	Air braking systems; hoses; requirements, tests	12.93
<b>HOSE ASSEMBLIES</b>		
DIN EN 982	Safety of machinery – safety requirements for fluid power systems and their components – hydraulics; German version EN 982: 1996	09.96
DIN EN 12115	Rubber and thermoplastic hoses and hose assemblies for liquid and gaseous chemicals – Specification; German version EN 12115: 1999	08.99
VG 95922-2	Hose assemblies for fluid power service; technical specification	07.94
DIN 2825	Hose assemblies made of elastomers for steam and hot water; general requirements	02.94
7716	Rubber products; requirements for storage, cleaning and maintenance	05.82
20018-1	Textile-reinforced hoses; rated for PN 10 and PN 16	06.91
20018-2	Textile-reinforced hoses; rated for PN 40	06.91
20018-3	Textile-reinforced hoses; rated for PN 100	06.91

# Technical Information

## HANSA-FLEX Hose Connections

<b>Terms</b>	<b>Contents</b>	<b>Edition</b>
20078-1	Fluid power; hose fittings; requirements, assembling instructions, test methods	02.82
20078-4	Fluid power; hose fitting male stud, type D, light series (L); dimensions	02.82
20078-5	Fluid power; hose fitting male stud, type E, heavy series (S); dimensions	02.82
20078-8	Fluid power; hose fitting swivel female with O-ring, type N, light series (L); dimensions	02.82
20078-9	Fluid power; hose fitting swivel female with O-ring, type P, heavy series (S); dimensions	02.82
20078-10	Fluid power; hose fitting 4-bolt split flange type, type R, standard pressure series; dimensions	02.82
20078-12	Fluid power; hose fitting 4-bolt split flange type, type S, high pressure series; dimensions	02.82
<b>HOSE ASSEMBLIES</b>		
20066	Fluid power; hose assemblies; dimensions, requirements	02.82
20066-4	Fluid power; hose assemblies; installation	05.84
20066-5	Fluid power; hose assemblies; assessment of service performance	06.93

# Technical Information

## HANSA-FLEX Hose Connections

### 1.5 Hose Assemblies: How to use the HANSA-FLEX designation

HANSA-FLEX hose assemblies are designated using the following system:

The first two letters and numbers indicate the hose type and the respective ferrule. This is followed by the overall length and information regarding the fittings on both ends.

The code describing the fitting is only mentioned once in case the hose assembly is manufactured using the same fitting type on both ends.

The designation is completed by information about additional parts such as spring guards and the angular displacement of the fittings. Please see the following examples for information:

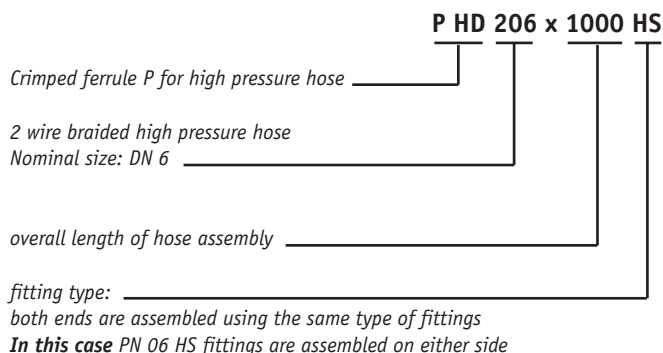

#### second example:

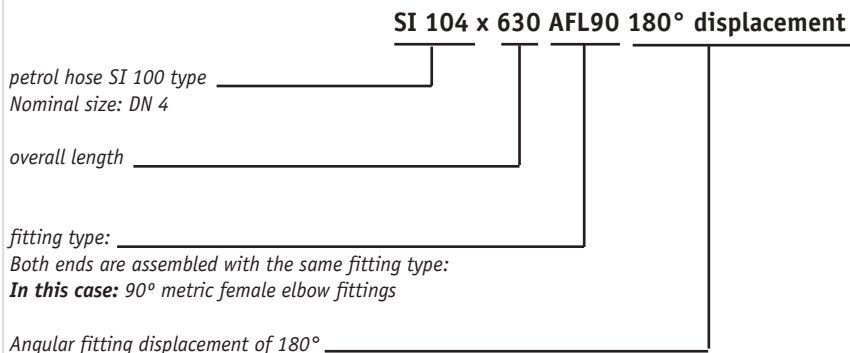

Designations for additional equipment are added to the code:

PHD 216 x 620 AJ AJ90 SSK. This assembly is equipped with an additional plastic protection against abrasion..

## Technical Information

### HANSA-FLEX Hose Connections

or:

**P HD 210 x 2000 AOL AFLO8 90**

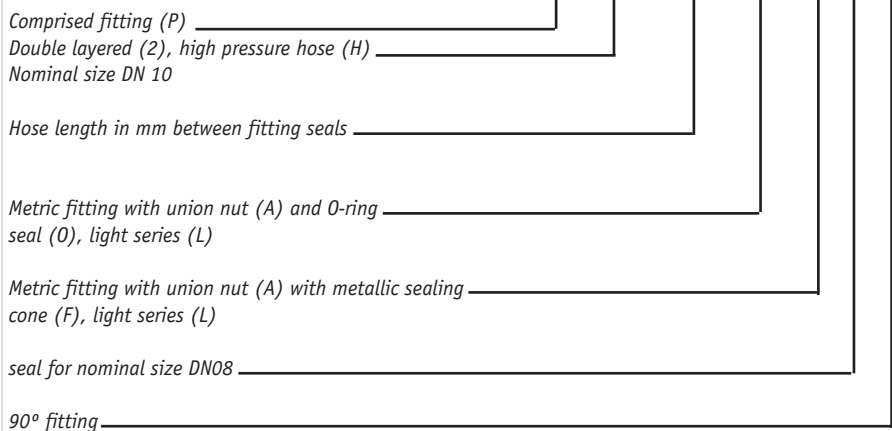

Fittings for either one or double wire braided textile hoses are always marked with the abbreviation PN.

## Technical Information

### HANSA-FLEX Hose Connections

or:

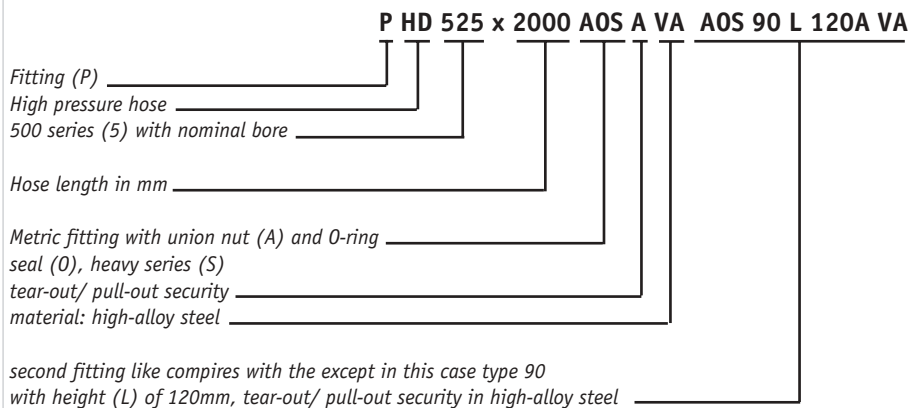

Fittings for high pressure hoses of the series HD 400, 500, 600 and 700 are marked with the abbreviation PA, thereby fitting and socket are joint in pairs.

# Technical Information

## HANSA-FLEX Hose Connections

### 2 Systems of Units and Conversions

#### 2.1 Physical quantities, units and conversions

The term *Hydraulics* describes the applied science and technology which deals with the laws governing liquid flow and pressure through pipe and hose assemblies. The following table shows the most common physical quantities, units and conversions:

Quantity	Unit	SI / Imperial	Conversion
mass	Kilogram	kg	1kg = 2,2046 lb
	pound (GB)	lb	1lb = 0,4535 kg
force	Newton	N (1N = 1kg m/s <sup>2</sup> )	1N = 0,2248 lbf
	pound force (GB)	lbf	1lbf = 4,4482 N
power	Watt	W (1W = 1kg m <sup>2</sup> /s <sup>3</sup> )	1W = 0,7374 ft lbf / s
	foot pound force per second	ft lbf / s	1ft lbf / s = 1,356 W
length	Meter	m	1m = 3,2808 ft
	Millimeter	mm	1mm = 0,03937 in
length	foot (GB)	Ft	1ft = 0,3048 m
	inch (GB)	In	1in = 25,4 mm
area	square meter	m <sup>2</sup>	1m <sup>2</sup> = 1550 in <sup>2</sup>
	square centimeter	cm <sup>2</sup>	1cm <sup>2</sup> = 0,1550 in <sup>2</sup>
	square inch (GB)	in <sup>2</sup>	1in <sup>2</sup> = 6,45 cm <sup>2</sup>
volume	cubic meter	m <sup>3</sup>	1 m <sup>3</sup> = 1000 liter
	cubic centimeter	cm <sup>3</sup>	1cm <sup>3</sup> = 0,0610 in <sup>3</sup>
	cubic inch (GB)	in <sup>3</sup>	1 in <sup>3</sup> = 16,387 cm <sup>3</sup>
	gallon (GB)	Gal	1gal = 4,5460 liter
	gallon (US)	Gal	1gal = 3,785 liter
pressure	Bar	bar (1bar = 10 <sup>5</sup> N/m <sup>2</sup> )	1bar = 14,5035 psi
	mega-pascal	MPa (1MPa = 10 bar)	1MPa = 145,035 psi
	kilo-pascal	KPa (1KPa = 0,01bar)	1KPa = 0,1450 psi
	pound-force per square inch	lbf = psi	1 psi = 0,0689 bar
flow rate	liters per second	l/s (l/s=0,001m <sup>3</sup> /s)	
	liters per minute	l/min (l/min=0,001m <sup>3</sup> /min)	1l/min = 0,2199 gal/min (GB) 1l/min = 0,2642 gal/min (US)
	gallons per minute (GB)	gal/min	1gal/min = 4,5460 liter/min
	gallons per minute (US)	gal/min	1gal/min = 3,785 liter/min
	viscosity	Centistokes	cSt (cSt = mm <sup>2</sup> /s)

# Technical Information

## HANSA-FLEX Hose Connections

Auxiliary chart for converting pressure units

Units	Pa = 1 N/m <sup>2</sup>	MPa	bar	at = kp/cm <sup>2</sup>	Atm
1 Pa = 1 N/m <sup>2</sup>	1	0,000001	0,00001		
1 Mpa	1.000.000	1	10	10,19716	9,86923
1 bar	100.000	0,1	1	1,01972	0,98692
1 at = 1 kp/cm <sup>2</sup>	98066,5	0,09806	0,98066	1	0,96784
1 atm	101325	0,10133	1,01325	1,03323	1

Pressure is known to form the quotient from force  $F$  per surface  $A$ :  $p = F/A$

Force  $F$  is measured in the unit Newton, face  $A$  in square metre  $m^2$ . The unit for pressure therefore is determined as  $N/m^2$ , **Pascal (Pa)**.

Within the technical area pressure units such as MegaPascal (**MPa**), HektoPascal (**hPa**) or bar (**bar**) are being utilised. Lower pressure ranges though are being stipulated with the unit millibar (mbar).

**Note:** former pressure ranges such as at, atm, Torr and mmWS are no longer admissible!

### Example:

3,67 Mpa are given. That equals how much bar pressure?

1. Go down the first cell ("Units") to 1 Mpa.
2. Within the row "bar" go right to the value "10".
3. We are looking upon the value 3,67 Mpa, therefore we multiply this quantum with the value "10".
4. Result: 3,67 Mpa = 3,67 x 10 = **36,7 bar**.

## 2.2 Determination of nominal dimension with the nomogram

How can now the inner diameter of a hydraulic hose be determined? Generally the conveying volume of the pump as well as the admissible working pressure are known to the user. The following chart however indicates a recommended value for flow velocity in dependance from the working pressure. Each value has to be allocated to a certain pressure value upfront.

type of hose assemblyoperating	pressure	fluid velocity $v$
suction line		1,0 m/s
return line		2,0 m/s
pressure line	0 – 25 bar	3,0 m/s
	25 – 50 bar	4,0 m/s
	50 – 100 bar	4,5 m/s
	100 – 150 bar	5,0 m/s
	150 – 210 bar	5,5 m/s

# Technical Information

## HANSA-FLEX Hose Connections

210 – 315 bar

6,0 m/s

Mark the value for the fluid velocity in the right column of the nomogram and determine the value for the flow rate in the left column. Connect these two point. The intersection in the center column will give the desired internal hose diameter:

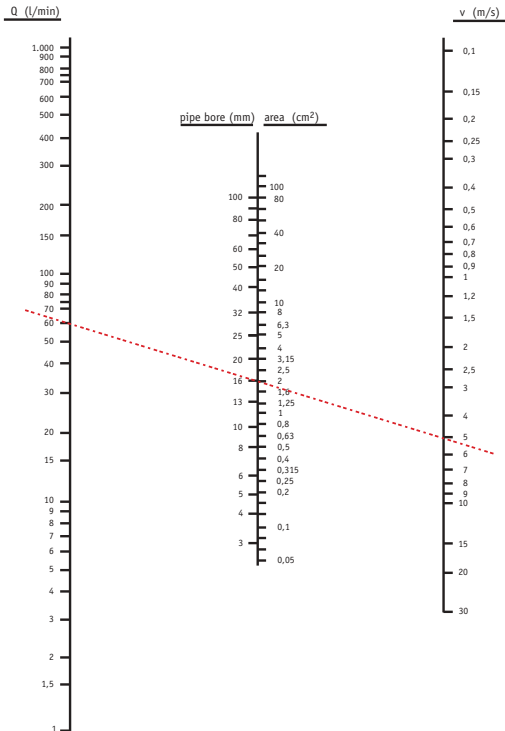

### Example:

Determine a suitable internal hose diameter for a hydraulic system with a flow rate  $Q = 80$  l/min and a nominal pressure  $PN = 35$  bar.

### Solution:

Choose a fluid velocity of 4,0 m/s from the previous chart and mark it in the left column. Enter the value for the flow rate  $Q$  in the right column. Connect the two markings. Read the required internal diameter from the intersection of the center column ( $d =$  approx. 20 mm).

## Technical Information

### HANSA-FLEX Hose Connections

#### 2.3 Weight Chart for hose yard goods

<i>HF-designation</i>	<i>Standard designation</i>	<i>Weight in kg/m</i>
TE 104	Hose EN 854 – 1TE 05	0,10
TE 106	Hose EN 854 – 1TE 06	0,12
TE 108	Hose EN 854 – 1TE 08	0,14
TE 110	Hose EN 854 – 1TE 10	0,16
TE 113	Hose EN 854 – 1TE 12	0,20
TE 116	Hose EN 854 – 1TE 16	0,29
TE 120	Hose EN 854 – 1TE 19	0,33
TE 125	Hose EN 854 – 1TE 25	0,49
TE 204	Hose EN 854 – 2TE 05	0,10
TE 206	Hose EN 854 – 2TE 06	0,13
TE 208	Hose EN 854 – 2TE 08	0,14
TE 210	Hose EN 854 – 2TE 10	0,17
TE 213	Hose EN 854 – 2TE 12	0,21
TE 216	Hose EN 854 – 2TE 16	0,29
TE 220	Hose EN 854 – 2TE 19	0,36
TE 225	Hose EN 854 – 2TE 25	0,52
TE 232	Hose EN 854 – 2TE 31	0,69
TE 304	Hose EN 854 – 3TE 05	0,14
TE 306	Hose EN 854 – 3TE 06	0,15
TE 308	Hose EN 854 – 3TE 08	0,21
TE 310	Hose EN 854 – 3TE 10	0,23
TE 313	Hose EN 854 – 3TE 12	0,29
TE 316	Hose EN 854 – 3TE 16	0,39
TE 320	Hose EN 854 – 3TE 19	0,45
TE 325	Hose EN 854 – 3TE 25	0,57
TE 332	Hose EN 854 – 3TE 31	0,63
TE 340	Hose EN 854 – 3TE 38	1,06
TE 350	Hose EN 854 – 3TE 51	1,27
HD 106	Hose EN 853 – 1SN 06	0,23
HD 108	Hose EN 853 – 1SN 08	0,27
HD 110	Hose EN 853 – 1SN 10	0,33

## Technical Information

### HANSA-FLEX Hose Connections

<i>HF-designation</i>	<i>Standard designation</i>	<i>Weight in kg/m</i>
HD 113	Hose EN 853 – 1SN 12	0,42
HD 116	Hose EN 853 – 1SN 16	0,49
HD 120	Hose EN 853 – 1SN 19	0,62
HD 125	Hose EN 853 – 1SN 25	0,94
HD 132	Hose EN 853 – 1SN 31	1,28
HD 140	Hose EN 853 – 1SN 38	1,53
HD 150	Hose EN 853 – 1SN 51	2,17
HD 106 A	Hose EN 853 – 1ST 06	0,30
HD 108 A	Hose EN 853 – 1ST 08	0,36
HD 110 A	Hose EN 853 – 1ST 10	0,43
HD 113 A	Hose EN 853 – 1ST 12	0,54
HD 116 A	Hose EN 853 – 1ST 16	0,64
HD 120 A	Hose EN 853 – 1ST 19	0,78
HD 125 A	Hose EN 853 – 1ST 25	1,11
HD 132 A	Hose EN 853 – 1ST 31	1,50
HD 140 A	Hose EN 853 – 1ST 38	1,75
HD 150 A	Hose EN 853 – 1ST 51	2,56
HD 204	Hose EN 853 – 2SN 05	0,32
HD 206	Hose EN 853 – 2SN 06	0,37
HD 208	Hose EN 853 – 2SN 08	0,41
HD 210	Hose EN 853 – 2SN 10	0,52
HD 213	Hose EN 853 – 2SN 12	0,63
HD 216	Hose EN 853 – 2SN 16	0,74
HD 220	Hose EN 853 – 2SN 19	0,92
HD 225	Hose EN 853 – 2SN 25	1,35
HD 232	Hose EN 853 – 2SN 31	2,00
HD 240	Hose EN 853 – 2SN 38	2,35
HD 250	Hose EN 853 – 2SN 51	3,16
HD 204 A	Hose EN 853 – 2ST 05	0,39
HD 206 A	Hose EN 853 – 2ST 06	0,45
HD 208 A	Hose EN 853 – 2ST 08	0,51
HD 210 A	Hose EN 853 – 2ST 10	0,63
HD 213 A	Hose EN 853 – 2ST 12	0,77
HD 216 A	Hose EN 853 – 2ST 16	0,88

## Technical Information

### HANSA-FLEX Hose Connections

<i>HF-designation</i>	<i>Standard designation</i>	<i>Weight in kg/m</i>
HD 220 A	Hose EN 853 – 2ST 19	1,09
HD 225 A	Hose EN 853 – 2ST 25	1,51
HD 232 A	Hose EN 853 – 2ST 31	2,33
HD 240 A	Hose EN 853 – 2ST 38	2,68
HD 250 A	Hose EN 853 – 2ST 51	3,62
HD 406	Hose EN 856 – 4SP 06	0,59
HD 410	Hose EN 856 – 4SP 10	0,76
HD 413	Hose EN 856 – 4SP 12	0,90
HD 416	Hose EN 856 – 4SP 16	1,12
HD 420	Hose EN 856 – 4SP 19	1,48
HD 520	Hose EN 856 – 4SH 20	1,50
HD 525	Hose EN 856 – 4SH 25	2,06
HD 532	Hose EN 856 – 4SH 31	2,54
HD 540	Hose EN 856 – 4SH 38	3,28
HD 550	Hose EN 856 – 4SH 51	4,58
HD 650	SAE 100 R13 2"	6,90
HD 720	SAE 100 R15 3/4"	1,53
HD 725	SAE 100 R15 1"	2,07
HD 732	SAE 100 R15 1 1/4"	3,60
HD 740	SAE 100 R15 1 1/2"	4,87
HD 750	SAE 100 R15 2"	6,67

# Technical Information

## HANSA-FLEX Hose Connections

### 2.4 Preferred pressure ranges within individual areas

In unawareness of operating pressures please refer to the following scopes of pressure values for correct selection and calculation of connections:

#### **Agricultural machinery**

Tillage implements, tractors, combine harvester 150 up to 220 bar  
propulsion combines harvester 420 bar

#### **Building and public utilities vehicles, lifting devices**

Excavators, planers, loaders, crane, hoists and driving impetus up to 420 bar  
Mini excavators 160 up to 260 bar  
Excavators over 13t 320 bar

#### **Synthetics processing machines**

Blast machine 100 up to 250 bar  
Injection moulding machines 150 up to 320 bar

#### **Forestry machineries**

Crane operation 180 up to 280 bar  
Driving operation 380 up to 420 bar

#### **Metallurgical and rolling mill machinery**

Rolling plant 100 up to 320 bar  
Continuous casting installations 150 up to 250 bar  
Pendulum shears 320 bar

#### **Machine tools, non-cutting**

Material testing presses 320 up to 700 bar and higher  
Ceramics and plastic presses 260 up to 320 bar  
Edging press/ drawing press 200 up to 320 bar  
„Lucas“ press 900 bar

#### **Machine tools, cutting**

Chucking device 10 up to 600 bar  
Planing and slotting machines 50 up to 120 bar  
Drilling and lathing machines 20 up to 60 bar  
Grinding machines 10 up to 30 bar

#### **First aid/ evacuation equipment**

Rescue shears, expander 700 bar  
Enerpac hand lever pumps 900 bar

#### **Lift mechanisms**

Person and freight elevators 40 up to 60 bar

# Technical Information

## HANSA-FLEX Hose Connections

Other definitions permit also certain conclusions concerning **operating pressure level**:

Maximum pressure systems	higher than 450 bar
High pressure systems	350 up to 450 bar
Medium high pressure systems	250 up to 350 bar
Medium pressure systems	100 up to 250 bar
Low pressure systems	1 up to 150 bar

### 2.5 Frequently used terms

- ANSI = American National Standards Institute
- ASME = The American Society of Mechanical Engineers
- BSP = British Standard Pipe Thread
- BSPT = British Standard Pipe Thread Tapered
- The extend of tolerance are often also displayed for these specific thread types by adding the letter P.  
Example:  
BSP-P = cylindrical tube thread, fine screw thread  
BSP-PP = cylindrical tube thread, extra fine screw thread
- JIC = Joint Industry Conference
- NPSM = National Pipe Straight Mechanical Thread
- NPT = National Standard Taper Pipe Thread
- ORFS = O-Ring Face Seal
- UN-Thread. Unity 8-, 12- and 16 turn thread
- UNF-Thread. Unity fine screw thread
- UNS-Thread. Special fine screw thread
- SAE = Society of Automotive Engineers

# Technical Information

## HANSA-FLEX Hose Connections

### 2.6 Measuring technique

#### 2.6.1. Examples for hose connections

The overall length of a hose assembly is defined by the length between the sealing cones of the fittings as shown below:



# Technical Information

## HANSA-FLEX Hose Connections

### 2.6.2 Displaced elbow fittings

Hose assemblies manufactured with displaced elbow fittings are designated as follows:

The first fitting is shown assembled in an upright position. If the two fittings are assembled with a positive 90° angular displacement, then the second fitting is turned clockwise as shown below. Please note that this only refers to HANSA-FLEX designations, there are other manufacturers using counter-clockwise displacements.

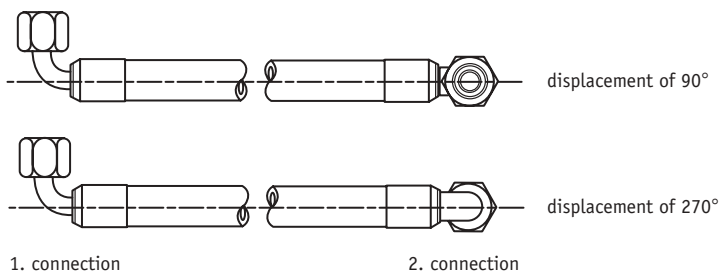

### 2.6.3 Recommended lengths

Tolerances and recommended lengths for hose assemblies are standardised in the current edition of DIN 20066:

a) recommended lengths:

160	200	250	315	400	500	630	800	1000	1250	1400	1600
1800	2000	2500	3150	4000	5000	6300	8000	10 000	12 500	14 000	16 000

b) permissible deviations in length given in mm:

overall length	up to DN 25	from DN 32 to DN 50	from DN 50 to DN 100
up to 630	+7 / -3	+12 / -4	
from 630 to 1250	+12 / -4	+20 / -6	+25 / -6
from 1250 to 2500	+20 / -6	+25 / -6	
from 2500 to 8000		+1,5% / -0,5%	
more than 8000		+3% / -1%	

# Technical Information

## HANSA-FLEX Hose Connections

### 2.7 Thread chart

#### 2.7.1 Metric thread

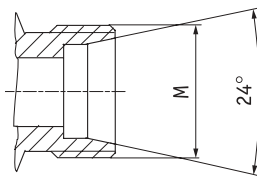
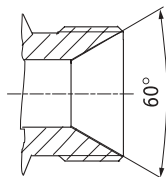

Metric thread	Hose dimensions			Ø outside	Ø inside	DN DIN 7631 60°	pipe O.D.				
	DN	BSP	inch				DIN light series 24°	DIN heavy series 24°	fr. mm 24°	fr. 24°	
M 12-1				12,00	11,00					6	
M 12-1,5	5	1/8	2	12,00	10,50	4	6				
M 14-1,5	5+6	1/8+1/4	2+4	14,00	12,50	6	8	6	8		
M 16-1,5	6	1/4	4	16,00	14,50			8			
M 16-1,5	8	5/16	5	16,00	14,50	8	10		10		
M 18-1,5	6	1/4	4	18,00	16,50			10			
M 18-1,5	10	3/8	6	18,00	16,50	10	12		12		
M 20-1,5	8	5/16	5	20,00	18,50			12	14	13,25	
M 22-1,5	10	3/8	6	22,00	20,50			14			
M 22-1,5	12	1/2	8	22,00	20,50	12	15		15		
M 24-1,5	12	1/2	8	24,00	22,50			16	16	16,75	
M 26-1,5	16	5/8	10	26,00	24,50	16	18				
M 27-1,5	16	5/8	10	27,00	25,50					18	
M 30-1,5	20	3/4	12	30,00	28,50	20			22	21,25	
M 30-2	16	5/8	10	30,00	27,90			20			
M 30-2	20	3/4	12	30,00	27,90		22				
M 33-1,5	20	3/4	12	33,00	31,50					25	
M 36-1,5	25	1	16	36,00	34,50					28	26,75
M 36-2	20	3/4	12	36,00	33,90			25			
M 36-2	25	1	16	36,00	33,90		28				
M 38-1,5	25	1	16	38,00	36,50	25					
M 39-1,5	25	1	16	39,00	37,50					30	

## Technical Information

### HANSA-FLEX Hose Connections

Metric thread	Hose dimensions			∅ outside	∅ inside	DN DIN 7631 60°	pipe O.D.				
	DN	BSP	inch				DIN light series 24°	DIN heavy series 24°	fr. mm 24°	fr. 24°	
M 42-1,5	25	1	16	42,00	40,50					32	
M 42-2	25	1	16	42,00	39,90			30			
M 45-1,5	32	1 1/4	20	45,00	43,00	32				35	
M 45-2	32	1 1/4	20	45,00	42,90		35				
M 48-1,5	32	1 1/4	20	48,00	46,50					38	
M 52-1,5	40	1 1/2	24	52,00	50,50	40					
M 52-2	32	1 1/4	20	52,00	49,90			38			
M 52-2	40	1 1/2	24	52,00	49,90		42				
M 54-2	40	1 1/2	24	54,00	51,90					45	
M 58-2	40	1 1/2	24	58,00	55,90						48,25
M 65-2	50	2	32	65,00	62,90	50					
M 78-2	60			78,00	75,90	60					
M 90-2	70			90,00	87,90	70					
M 100-2	80			100,00	97,90	80					
M 110-2	90			110,00	107,90	90					
M 120-2	100	4	64	120,00	117,90	100					

# Technical Information

## HANSA-FLEX Hose Connections

### 2.7.2 BSP thread

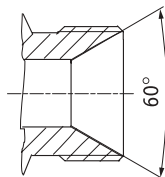

BSP thread	turn per inch	hose dimensions			outer Ø	inner Ø
		DN	BSP	inch		
G 1/8"	28	5	1/8	2	9,73	8,60
G 1/4"	19	6	1/4	4	13,16	11,50
G 3/8"	19	10	3/8	6	16,66	14,90
G 1/2"	14	12	1/2	8	20,96	18,60
G 5/8"	14	16	5/8	10	22,91	20,60
G 3/4"	14	20	3/4	12	26,44	24,10
G 1"	11	25	1	16	33,25	30,30
G 1 1/4"	11	32	1 1/4	20	41,91	38,90
G 1 1/2"	11	40	1 1/2	24	47,80	44,90
G 2"	11	50	2	32	59,62	56,70

# Technical Information

## HANSA-FLEX Hose Connections

### 2.7.3 NPT thread

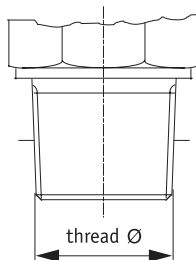

NPT-thread	hose dimensions			outer Ø	inner Ø
	DN	inch	Size		
1/8"-27	5	1/8	2	9,70	8,60
1/4"-18	6	1/4	4	13,10	11,30
3/8"-18	10	3/8	6	16,30	15,10
1/2"-14	12	1/2	8	20,20	18,60
3/4"-14	20	3/4	12	25,50	24,10
1"-11,5	25	1	16	32,20	30,20
1"1/4-11,5	32	1 1/4	20	41,00	38,90
1"1/2-11,5	40	1 1/2	24	47,00	44,90
2"-11,5	50	2	32	58,90	56,70

# Technical Information

## HANSA-FLEX Hose Connections

### 2.7.4 UN/UNF thread

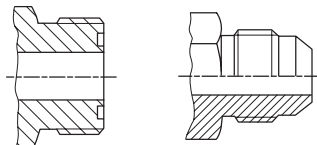

UN / UNF Thread	hose dimensions			O.D.	I.D.	Obs.
	DN	inches	Size			
5/16-24 UN	5	1/8	2	7,94	7,15	JIC
3/8-24 UNF	5	3/16	3	9,52	8,60	JIC
7/16-20 UNF	6	1/4	4	11,07	10,00	JIC + SAE
1/2-20 UNF	8	5/16	5	12,70	11,60	JIC + SAE
9/16-18 UNF	10	3/8	6 + 4	14,25	13,00	JIC + ORS
5/8-18 UNF	10	3/8	6	15,85	14,70	SAE
11/16-16 UN	10	3/8	6	17,40	15,40	ORS
3/4-16 UNF	12	1/2	8	19,00	17,60	JIC + SAE
13/16-16 UN	12	1/2	8	20,50	18,60	ORS
7/8-14 UNF	16	5/8	10	22,17	20,50	JIC + SAE
1 -14 UNS	16	5/8	10	25,30	23,10	ORS
1 1/16-12 UN	20	3/4	12	26,95	25,00	JIC
1 1/16-14 UNS	20	3/4	12	26,95	25,30	SAE
1 3/16-12 UN	20	3/4	14 + 12	30,10	27,50	JIC + ORS
1 5/16-12 UN	25	1	16	33,30	31,30	JIC
1 5/16-14 UNS	25	1	16	33,30	31,60	PTT
1 7/16-12	25	1	16	36,40	33,80	ORS
1 5/8-12 UN	32	1 1/4	20	41,22	39,20	JIC
1 5/8-14 UNS	32	1 1/4	20	41,22	39,50	PTT
1 11/16-12 UN	32	1 1/4	20	42,80	40,20	ORS
1 7/8-12 UN	40	1 1/2	24	47,57	45,60	JIC
1 7/8-14 UNS	40	1 1/2	24	47,57	45,90	PTT
2-14 UN	40	1 1/2	24	50,70	48,10	ORS
2 1/2-12 UN	50	2	32	63,45	61,50	JIC + PTT
3-12 UN	60	2 1/2	40	76,20	74,30	JIC
3 1/2-12 UN	80	3	48	88,90	87,00	JIC

## Technical Information

### HANSA-FLEX Hose Connections

#### 2.8 Comparison between DIN- and HANSA-FLEX terminology for hose fittings

DIN 20 078	A	C	D	E	N	P	R	S
HANSA-FLEX	AFL	A	HL	HS	AOL	AOS	SF	SF6

#### 2.9 Hose conduction accessories – summary and allocation

Hose	SGF	FBS	SSK	SSR	SSF	GKS	PKF	RKS
HD 104	SGF 13	FBS 014	SSK 07	SSR 14-2	SSF 13-1			
HD 106	SGF 15	FBS 016	SSK 07	SSR 14-2	SSF 15-1		PKF 17	
HD 106A	SGF 18	FBS 018	SSK 07	SSR 18-2	SSF 17-1		PKF 17	
HD 108	SGF 18	FBS 018	SSK 09	SSR 18-2	SSF 17-1		PKF 17	
HD 108A	SGF 18	FBS 018	SSK 09	SSR 18-2	SSF 19-1		PKF 17	
HD 110	SGF 19	FBS 020	SSK 09	SSR 18-2	SSF 19-1		PKF 22	
HD 110A	SGF 22	FBS 022	SSK 09	SSR 20-2	SSF 23-1		PKF 22	
HD 113	SGF 22	FBS 022	SSK 13	SSR 23-2	SSF 23-1		PKF 26	
HD 113A	SGF 24	FBS 026	SSK 13	SSR 23-2	SSF 26-1		PKF 26	
HD 116	SGF 24	FBS 026	SSK 16	SSR 27-2	SSF 26-1		PKF 29	
HD 116A	SGF 28	FBS 028	SSK 16	SSR 27-2	SSF 29-1		PKF 29	
HD 120	SGF 28	FBS 030	SSK 20	SSR 30-2	SSF 29-1		PKF 34	RKS 20
HD 120A	SGF 32	FBS 032	SSK 20	SSR 30-2	SSF 33-1		PKF 34	RKS 20
HD 125	SGF 38	FBS 038	SSK 25	SSR 41-3	SSF 41-1		PKF 42	RKS 25
HD 125A	SGF 42	FBS 040	SSK 25	SSR 41-3	SSF 41-1		PKF 42	RKS 25
HD 132	SGF 48	FBS 050	SSK 30	SSR 48-3	SSF 48-1		PKF 52	RKS 32
HD 132A	SGF 48	FBS 050	SSK 30	SSR 48-3	SSF 48-1		PKF 52	RKS 32
HD 140	SGF 55	FBS 055	SSK 30	SSR 52-3	SSF 54-1		PKF 52	RKS 40
HD 140A	SGF 55	FBS 055	SSK 30	SSR 52-3	SSF 54-1			RKS 40
HD 204	SGF 13	FBS 016	SSK 07	SSR 14-2	SSF 15-1			
HD 204A	SGF 15	FBS 016	SSK 07	SSR 18-2	SSF 17-1		PKF 17	
HD 206	SGF 15	FBS 018	SSK 07	SSR 18-2	SSF 17-1		PKF 17	
HD 206A	SGF 19	FBS 020	SSK 07	SSR 18-2	SSF 19-1		PKF 17	
HD 208	SGF 18	FBS 018	SSK 09	SSR 18-2	SSF 17-1		PKF 17	
HD 208A	SGF 22	FBS 022	SSK 09	SSR 20-2	SSF 23-1		PKF 17	
HD 210	SGF 19	FBS 022	SSK 09	SSR 20-2	SSF 23-1		PKF 22	
HD 210A	SGF 22	FBS 024	SSK 09	SSR 23-2	SSF 23-1		PKF 22	

## Technical Information

### HANSA-FLEX Hose Connections

Hose	SGF	FBS	SSK	SSR	SSF	GKS	PKF	RKS
HD 213	SGF 22	FBS 024	SSK 13	SSR 23-2	SSF 26-1		PKF 26	
HD 213A	SGF 28	FBS 026	SSK 13	SSR 27-2	SSF 26-1		PKF 26	
HD 216	SGF 28	FBS 028	SSK 16	SSR 27-2	SSF 26-1		PKF 29	
HD 216A	SGF 30	FBS 030	SSK 16	SSR 30-2	SSF 29-1		PKF 29	
HD 220	SGF 30	FBS 032	SSK 20	SSR 30-2	SSF 33-1		PKF 34	RKS 20
HD 220A	SGF 35	FBS 035	SSK 20	SSR 34-3	SSF 33-1		PKF 34	RKS 20
HD 225	SGF 42	FBS 040	SSK 25	SSR 41-3	SSF 41-1		PKF 42	RKS 25
HD 225A	SGF 42	FBS 045	SSK 25	SSR 41-3	SSF 41-1		PKF 42	RKS 25
HD 232	SGF 52	FBS 055	SSK 30	SSR 48-3	SSF 48-1		PKF 52	RKS 32
HD 232	SGF 52	FBS 055	SSK 30	SSR 48-3	SSF 54-1		PKF 52	RKS 32
HD 240	SGF 60	FBS 060	SSK 30					RKS 40
HD 406	SGF 19	FBS 020	SSK 07	SSR 20-2	SSF 19-1		PKF 17	
HD 410	SGF 22	FBS 024	SSK 09	SSR 23-2	SSF 23-1		PKF 23	
HD 413	SGF 28	FBS 028	SSK 13	SSR 27-2	SSF 26-1		PKF 26	
HD 420	SGF 32	FBS 035	SSK 20	SSR 34-3	SSF 33-1		PKF 34	RKS 20
HD 425	SGF 42	FBS 045	SSK 25	SSR 41-3	SSF 41-1		PKF 42	RKS 25
HD 520	SGF 32	FBS 035	SSK 20	SSR 34-3	SSF 33-1		PKF 42	RKS 20
HD 525	SGF 42	FBS 045	SSK 25	SSR 41-3	SSF 41-1			RKS 25
HD 532	SGF 48	FBS 050	SSK 30	SSR 48-3	SSF 48-1		PKF 52	RKS 32
HD 540	SGF 60	FBS 060	SSK 30				PKF 52	RKS 40
HD 550	SGF 75	FBS 075	SSK 50					
HF 108	SGF 18	FBS 018	SSK 09	SSR 18-2	SSF 17-1	GKS 08		
HF 110	SGF 19	FBS 020	SSK 09	SSR 18-2	SSF 19-1	GKS 10		
HF 113	SGF 22	FBS 022	SSK 13	SSR 23-2	SSF 23-1	GKS 13		
HW 108	SGF 18	FBS 018	SSK 09	SSR 18-2	SSF 17-1	GKS 08		
HW 110	SGF 19	FBS 020	SSK 09	SSR 18-2	SSF 19-1	GKS 10		
HW 113	SGF 22	FBS 022	SSK 13	SSR 23-2	SSF 23-1	GKS 13		
KP 208	SGF 18	FBS 018	SSK 09	SSR 18-2	SSF 17-1		PKF 17	
KP 210	SGF 19	FBS 020	SSK 09	SSR 18-2	SSF 19-1		PKF 22	
KP 213	SGF 22	FBS 022	SSK 13	SSR 23-2	SSF 23-1		PKF 26	
KP 216	SGF 24	FBS 026	SSK 16	SSR 27-2	SSF 26-1		PKF 29	
KP 220	SGF 28	FBS 030	SSK 20	SSR 30-2	SSF 29-1		PKF 34	RKS 20

## Technical Information

### HANSA-FLEX Hose Connections

Hose	SGF	FBS	SSK	SSR	SSF	GKS	PKF	RKS
KP 225	SGF 38	FBS 038	SSK 25	SSR 41-3	SSF 41-1		PKF 42	RKS 25
MD 104	SGF 13	FBS 016	SSK 07	SSR 14-2	SSF 15-1			
MD 106	SGF 15	FBS 018	SSK 07	SSR 18-2	SSF 15-1		PKF 17	
MD 108	SGF 19	FBS 020	SSK 09	SSR 18-2	SSF 19-1		PKF 17	
MD 110	SGF 22	FBS 022	SSK 09	SSR 20-2	SSF 23-1		PKF 22	
MD 113	SGF 24	FBS 026	SSK 13	SSR 23-2	SSF 26-1		PKF 26	
MD 116	SGF 28	FBS 030	SSK 16	SSR 30-2	SSF 29-1		PKF 29	
MD 120	SGF 35	FBS 035	SSK 20	SSR 34-2	SSF 33-1		PKF 34	RKS 20
MD 125	SGF 42	FBS 040	SSK 25	SSR 41-2	SSF 41-1		PKF 42	RKS 25
MD 132	SGF 48	FBS 050	SSK 30	SSR 48-3	SSF 48-1		PKF 52	RKS 32
MD 140	SGF 52	FBS 060	SSK 30	SSR 52-3	SSF 54-1			RKS 40
MD 150	SGF 52	FBS 060	SSK 50					
MD 204	SGF 13	FBS 016	SSK 07	SSR 14-2	SSF 15-1			
MD 206	SGF 15	FBS 018	SSK 07	SSR 18-2	SSF 15-1		PKF 17	
MD 208	SGF 19	FBS 020	SSK 09	SSR 18-2	SSF 19-1		PKF 17	
MD 210	SGF 22	FBS 022	SSK 09	SSR 20-2	SSF 23-1		PKF 22	
MD 213	SGF 24	FBS 026	SSK 13	SSR 23-2	SSF 26-1		PKF 26	
MD 216	SGF 28	FBS 030	SSK 16	SSR 30-2	SSF 29-1		PKF 29	
MD 220	SGF 35	FBS 035	SSK 20	SSR 34-3	SSF 33-1		PKF 34	RKS 20
MD 225	SGF 42	FBS 040	SSK 25	SSR 41-3	SSF 41-1		PKF 42	RKS 25
MD 232	SGF 48	FBS 050	SSK 30	SSR 48-3	SSF 48-1		PKF 52	RKS 32
ND 106	SGF 13	FBS 014	SSK 07	SSR 14-2	SSF 13-1			
ND 110	SGF 15	FBS 018	SSK 09	SSR 18-2	SSF 17-1			
ND 113	SGF 19	FBS 022	SSK 13	SSR 20-2	SSF 23-1			
ND 306	SGF 13	FBS 014	SSK 07	SSR 14-2	SSF 13-1			
ND 310	SGF 15	FBS 018	SSK 09	SSR 18-2	SSF 17-1			
ND 313	SGF 19	FBS 022	SSK 13	SSR 20-2	SSF 23-1			
ND 316	SGF 24	FBS 024	SSK 16	SSR 23-2	SSF 23-1			
ND 320	SGF 28	FBS 028	SSK 20	SSR 27-2	SSF 29-1			

# Technical Information

## HANSA-FLEX Hose Connections

### 2.10 Hose type selection for hot water transport and steam feed

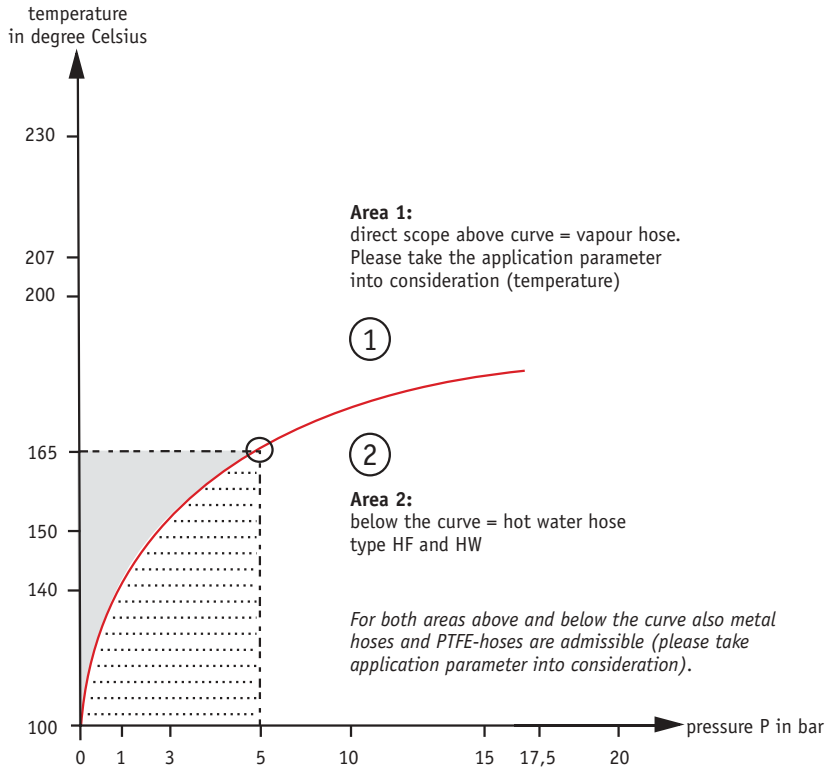

Every single dot along the curve displays the boundary between hot water and saturated steam.

# Technical Information

## HANSA-FLEX Hose Connections

### 3. Hose fittings – Security information

*The potential threats to humans and the environment caused by high pressure hydraulic hose assemblies are often underestimated. Oil leakages caused by pinholes, bursted hoses or torn-off fittings may result in lethal injuries.*

*Therefore we would like to present extracts from the respective technical rules, standards and our practical experience.*

#### 3.1 Storage and lifetime of hoses and hose assemblies

*As rubber elastomers used in fluid technology are also prone to aging processes, the duration of storage and operation is limited to only a certain time.*

*Unsuitable storage conditions are likely to cause premature embrittlement of rubber hose material, please note that we have already pointed out the harmful impacts of ozone and UV-radiation.*

**N.B.:** *electric welding will produce high concentrations of ozone, proper air ventilation should be installed when weldings are carried out close to rubber hoses. We also advise to shield hose assemblies from intensive UV-radiation caused by electric welding.*

*Ozone concentrations are also caused by carbon brush sets of electric engines.*

*The requirements for storage, cleaning and maintenance are stated in the current editions of DIN 20 066 and DIN 7716:*

- *General requirements:*

*„Unsuitable storage conditions or improper treatment can alter the physical properties of most products made from rubber elastomers. This can shorten the product life time showing effects like hardened or softened surfaces, constant deformation, material cracks or other various insufficiencies.*

*These changes of the material properties can be caused by the impacts of oxygene, ozone, heat, light, humidity, detergents or the product storage subjected to mechanical tensions.*

*Properly stored and treated rubber products, however, do not change their material properties over longer periods. Please note this does only refer to vulcanized elastomer blends.“*

- *Store room:*

*„The store room shall be chilled, free from dust und moderately ventilated. Rubber products must not be stored outside of buildings.*

- *Temperature:*

*„The storage temperature for rubber elastomer products depends on the type of elastomers. Rubber products shall be stored under temperatures ranging from -10° C to +15° Celsius, the upper temperature limit may be exceeded to a maximum of 25° Celsius.*

## Technical Information

### HANSA-FLEX Hose Connections

*Certain elastomer types such as chloroprene-rubber CR may require storage temperatures not lower than 12° Celsius.*

*Non-vulcanized rubber products and blends shall be stored in a surrounding temperature from +15° Celsius to 25° Celsius. Higher temperatures must and lower temperatures should be avoided.*

*Suitable adhesives and detergents must not be stored with temperatures lower than 0° Celsius.*

*Products which have been subjected to low temperatures during transport or storage might have become stiff. Low temperatures can also severely reduce adhesive forces."*

- **Room heating:**

*„Rubber products have to be shielded against heating bodies. The minimum distance between the stored goods and the heating device must be 1 meter. Store rooms heated by hot air systems require even greater distances.“*

- **Humidity:**

*„Storage rooms should be kept dry. Condensation must be avoided. An air humidity rate lower than 65% is recommended.“*

- **Lighting:**

*„The products should be protected from light, this particularly refers to direct sunlight and intensive artificial light with a high ultra-violet radiation.*

*Storage room windows should be painted with a red or orange coloured protection. Blue paint must not be used under any circumstances.*

*For lighting standard electric bulbs are recommended.“*

- **Ozone and oxygene:**

*„The stored products shall be protected from air drafts by a suitable cover. This is particularly important for products with a big surface / volume ratio.*

*Storage rooms must be free from ozone producing devices such as electric appliances and other devices as ozone is particularly harmful to rubber materials.*

*This also refers to combustion fumes and vapours which might produce ozone caused by photo-chemical processes.“*

- **Additional remarks:**

*„Detergents, fuels, lubricants, chemicals, acids and disinfection solvents must not be kept in the storage room. Rubber solutions must be stored following local rules for storage and transport of inflammable liquids.“*

- **Storage and handling:**

*„Rubber products must be stored stress free i.e. the products must be stored avoiding mechanical impacts*

## Technical Information

### HANSA-FLEX Hose Connections

*such as tension or compression as mechanical stresses are likely to cause cracks and constant deformations. O-rings must not be stored hanging from a hook.*

*Certain metals such as copper or manganese have harmful impacts on rubber products.*

*Rubber products must be properly covered or shielded if they can not be stored separately from these metals.*

*Anti-static foils made of paper, polyethylene or polyamide are recommended for protection. Foils containing softeners must not be used.*

*In case the products are covered with powder, the powder must not contain ingredients harmful to rubber elastomers.*

*Rubber products made of different elastomers should also be stored separately from each other. This particularly refers to products of different colours. It is recommended to store rubber products only for a rather short time, products arriving in storage should be separated from already stored products."*

*Note: Hydraulic hoses are often stored using the FIFO (First In First Out) principle.*

- *Cleaning and maintenance:*

*„Rubber products can be cleaned using soap and warm water. The cleaned products shall be dried at room temperature. It is also possible to clean rubber products using a 1,5% solution of natriumbicarbonate after a longer (6-8 months) period of time. Please follow the manufacturer´s recommendation for cleaning rubber products.*

*Rubber products must not be cleaned using detergents such as trichloride-ethylene, abrasive devices like sand paper or wire brushes should also not be utilised. Connections of rubber and metal shall be cleaned using a solution of glycerine and spirit (1:10).*

*Rubber products must be thoroughly cleaned before disinfections. The disinfection solution must not be used as a cleaning detergent.*

*Please also check the chemical compatibility of rubber products with the disinfection solution.*

## Technical Information

### HANSA-FLEX Hose Connections

*The manufacturer must also be consulted for cleaning rubber products determined for medical purposes.“*

*The current edition of DIN 20066 specifies the following rules:*

*„Hoses and hose assemblies are prone to a natural ageing process even when stored under optimum conditions. Therefore the product life time is limited.*

*Improper storage, mechanical damages and inadequate operating conditions are the main reasons for premature failure. The following periods of operation are specified:*

*For the manufacture of a hose assembly the age of the hose material shall not exceed 4 years.*

*The life time of a hose assembly shall not exceed a period of six years including a possible store period of 2 years.*

*Please consider the diagram below:*

#### Storage and utilisation limits according to DIN 20066, part 5

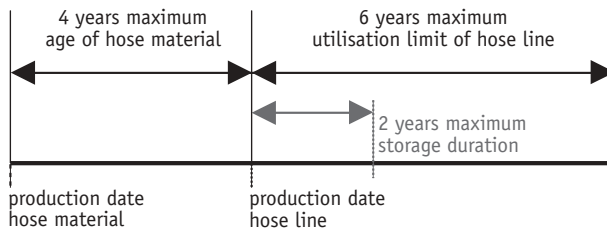

*For how long hose lines can be utilised=*

- General requirements of the EN 982, 5.3.4.3 – please take hose line into consideration.*
- Storage and utilisation limits / durations according to DIN 20066, part 5 as a recommendation*
- UVV 14 lifting platforms requires a utilisation limit / use duration of a hose line of 6 years maximum in accordance with § 52 (3).*

## Technical Information

# HANSA-FLEX Hose Connections

### 3.2 Inspection criteria

The function of hose assemblies is to be assessed in certain time intervals which are specified by government safety boards and applicable technical rules such as DIN 20066. Hose assemblies must be replaced once the following damages have been discovered:

Damages of the hose cover reaching down to the reinforcement layers caused by abrasion, cuts and cracks.

– Deformations which do not comply with the initial hose form such as the separation of hose layers.

– Damages and deformations of hose fittings causing leakages.

– Fittings and hose material have been torn apart.

– Fittings badly affected by corrosion.

– Hose assembly inadequately mounted to the hydraulic system. Please also see the following pages.

– Periods of storage and operating do not comply with the specification given before.

### 3.3 Repair of hose assemblies

We would like to quote DIN EN 982 „Safety of machinery – safety requirements for fluid power systems and their components – hydraulics“ which gives a detailed comment on the repair of hose assemblies:

“Hose assemblies must not be produced from hose material which has already been used for production purposes. Hose assemblies must comply with the relevant specifications given in the respective European and / or international standards. Recommendations for storage periods of hose assemblies should be considered.”

**Note:** Due to its status DIN EN 982 can be considered as the legal base for a judicial decision, this should be considered for compensation claims.

DIN EN 982 also specifies:

“Hose assemblies must be connected to hydraulic systems as follows:

– they must have the necessary length to avoid mechanical stresses caused by movements during operation.

– Hose assemblies shall not be twisted i.e. caused by defect rotary fittings.

– Hose assemblies must be protected from excessive abrasion of the cover.

– They must be adequately fixed to avoid stresses caused by their own weight.

– Fittings must be adequately fixed to avoid a whipping of the hose in case of accidents.

– Hose assemblies must be properly shielded if streaming oil leakages are likely to cause personal injuries.”

## Technical Information

### HANSA-FLEX Hose Connections

#### 3.4 Marking of hoses and hose assemblies

The relevant standards specify a detailed product marking for hoses and assemblies as these products are prone to material ageing as described before:

„Each hose assembly must be permanently marked with a manufacturer identification, the assembly date (year and month) and the maximum allowable working pressure.“

The marking of hose material is specified in the relevant industrial standard i.e. EN 853 for hydraulic hoses:

„Hoses shall be marked continuously with a minimum distance of 500 mm showing the following:

- Name and identification sign of manufacturer
- Number of European Standard i.e. EN 853
- Hose type i.e. 2ST
- Nominal diameter DN 16
- digits and letters indicating manufacturing quarter and year i.e. 4Q99

#### Example:

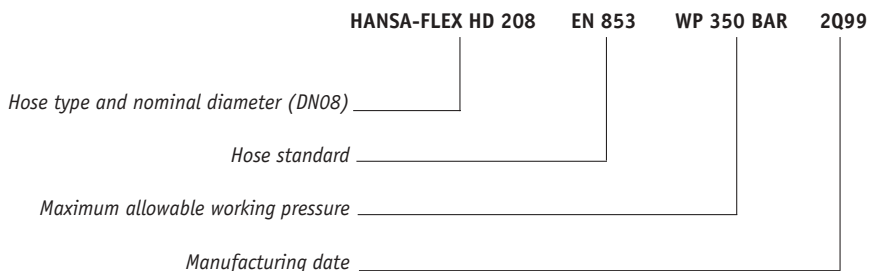

## Technical Information

# HANSA-FLEX Hose Connections

### 3.5 Connecting hose assemblies to hydraulic systems

Most failures were caused by an improper mounting of the hose assembly to the hydraulic system. In most cases hose assemblies had been subjected to inadmissible torsional stresses. Bending radii smaller than given in the specification and abrasion leading to corrosion of the reinforcement layers also caused numerous failures.

#### • Hose assemblies subjected to torsional loads

If a hose assembly is twisted when mounted to a system the product life time will be shortened considerably: The reinforcement layers will be moved into a forced position i.e. the layers are twisted against the longitudinal axis of the assembly. Due to their elastic behaviour the reinforcement layers will be moved back into their initial unstressed position when the assembly is subjected to dynamic loads.

Please note the subsequent information as a point of reference: a torsion of 7° only shortens the life span down to remarkable 80%!

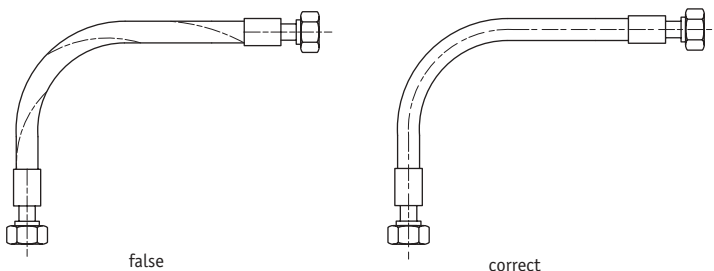

The life time of the assembly will then be shortened because of both inner friction.

Note: There are also particular high stresses in crimped fitting area.

The assembly must not be twisted under any circumstances if for instance the swivel nut is tightened.

Inadmissible torsional loads are also caused by an improper selection of the fitting types: The assembly shown in the left picture is subjected to inadmissible torsional loads caused by the movement of the right block leading to a shortened product life time.

#### • Minimum bending radius

If a hose assembly is mounted with a bending radius smaller than specified the product life time will be shortened considerably. A small bending radius will tear the reinforcing wire braid on the outside of the hose bend.

The wires forming the braid and carrying the pressure will be torn away from each other leaving the inside tube uncovered. This will result in high pressure oil rays finding their way through the hose wall.

On the inside of a sharp hose bend the reinforcement braid is also deformed: The reinforcement layers are pressed together and moved away from the inner hose tube. The tube can no longer be reinforced against hose pressure as it is no longer protected by these layers.

## Technical Information

### HANSA-FLEX Hose Connections

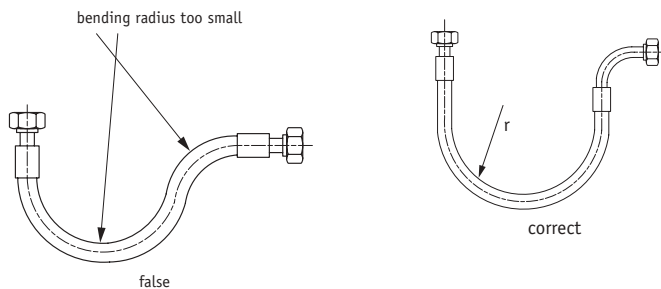

The bending on the hose line should initiate after 1,5 times the outer diameter, according to the conditions. If needed, the installation can be supported with a respective buckling protection.

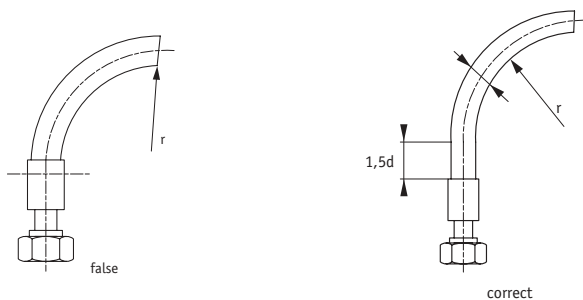

We advise suitable fitting types to avoid inadmissible small bending radii:

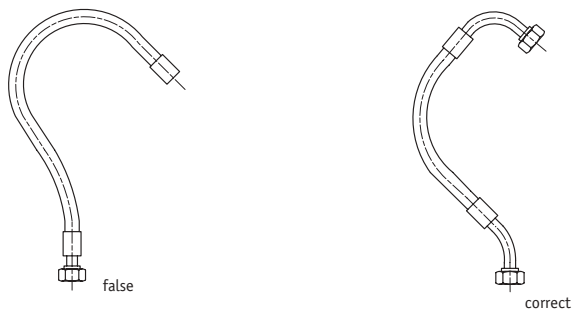

## Technical Information

### HANSA-FLEX Hose Connections

**Important:** High pressure oil rays piercing a hose wall are extremely dangerous. Due to its small size and high pressure the oil ray will penetrate human tissue without causing pain or visible injuries.

Please note that hydraulic fluids are contaminated with certain bacteria, the fluid will be dissolved in the surrounding weave and cause a potentially lethal blood poisoning.

A doctor must be consulted immediately once a member of staff has been injured by a high pressure oil ray.

Failures of hose assemblies are also caused by sharp bends close to the rear edge of the ferrule.

We advise hose bends to start from a straight section with a length equivalent to 1,5 times of the external hose diameter. In some cases it might be necessary to use an additional spring guard for protection against sharp bends.

#### • Abrasion

Hose movements caused by dynamic pressure loads will lead to abrasion if a hose assembly is mounted close to rigid edges. Bundled hoses are also likely to be affected by abrasion as their covers scrub against each other under dynamic loads. Once the cover has been destroyed by abrasion the reinforcement layers are no longer protected against humidity which will badly affect the wires causing corrosion.

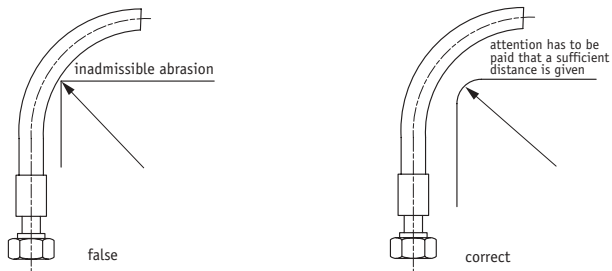

There are also hoses available with an additional PVC protection layer. They are less flexible and have a bigger bending radius.

# Technical Information

## HANSA-FLEX Hose Connections

### • Tensile loads

Hose assemblies must not be subjected to tensile loads as this will badly affect the connection of the hose material and the crimped fittings. Please consider that the length of a hose assembly may be shortened if the assembly is subjected to dynamic pressure loads.

We advise to add a certain extra length to a hose assembly as shown in the picture below, possible movements must be also considered:

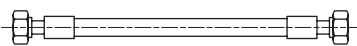

false \*



correct

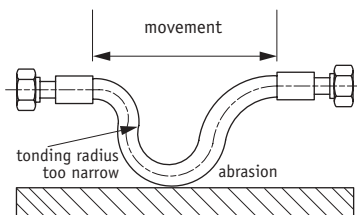

false

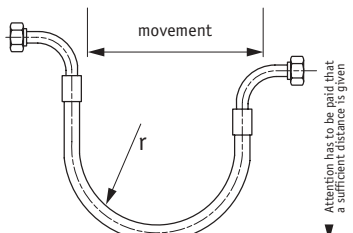

correct

\* Annotation: Concerning particular applications as for example strains to springs to the tensioner pulley a certain tensile stress is inevitable. Therefore all operating strains to the systems have to be clarified with the manufacturer.

### • Hose clamps

Hose clamps must not interfere with movements of the hose material caused by dynamic pressure loads: The pulsing oil flow pumped through the assembly shown in the left picture will also cause a regular movement of the hose bend.

These movements are likely to cause excessive abrasion as the hose bend can not freely move. Therefore hose clamps should be used only in straight sections allowing possible movements and the changes in length mentioned before.

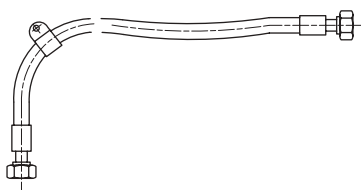

false

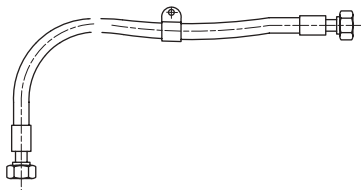

correct

## Technical Information

# HANSA-FLEX Hose Connections

### • Whipping

*In order to prevent the dangerous effect of whipping at a hose connection subsequent retrofit features are suitable to prevent failures or fractures:*

- covers
- canal conduct
- chain link between hose and connection point

*For an installation also with regards to a future-compatible type with longevity the most suitable solution is a contracting braided wire construction in order to ensure a fast connection between hose and machinery.*

### 3.6 Cold flow

*Elastomers under the influence of temperature do not show any flexible behaviour.*

*Despite chemical and physical networking a tendency to a material "creeping" can also be observed between nipples and socket. This viscoelastic behaviour may lead to a leakage or to a "drifting" of the hose fitting. Through the skiving process of the upper rubber cover within the prescribed scope it is feasible to eliminate at least this security risk on the hose.*

### 3.7 Behaviour towards gas and emitted fumes

*The choice of the right hose depends on the permeation or escape (the possible penetration of single gas molecules through the core). This process is dependant on pressure.*

*Hereby fluid losses or an unrestricted gas accumulation (gaseous petrol/ fuel) might be the consequence. Potentially these gas are flammable, explosive or toxic. A targeted release of possible gas concentrations underneath the upper cover is being performed by the so-called "pricking" method. This method can be applied at compressed air conduction over 16 bar or for example on hot water hoses.*

# Technical Information

## HANSA-FLEX Hose Connections

### 3.8 Pressure hierarchy

The subsequent diagramme displays the standardisation together with the designations and the terminology of important pressure descriptions and their positions towards each other. (status and sequence):

## Diagram of the pressure hierarchy

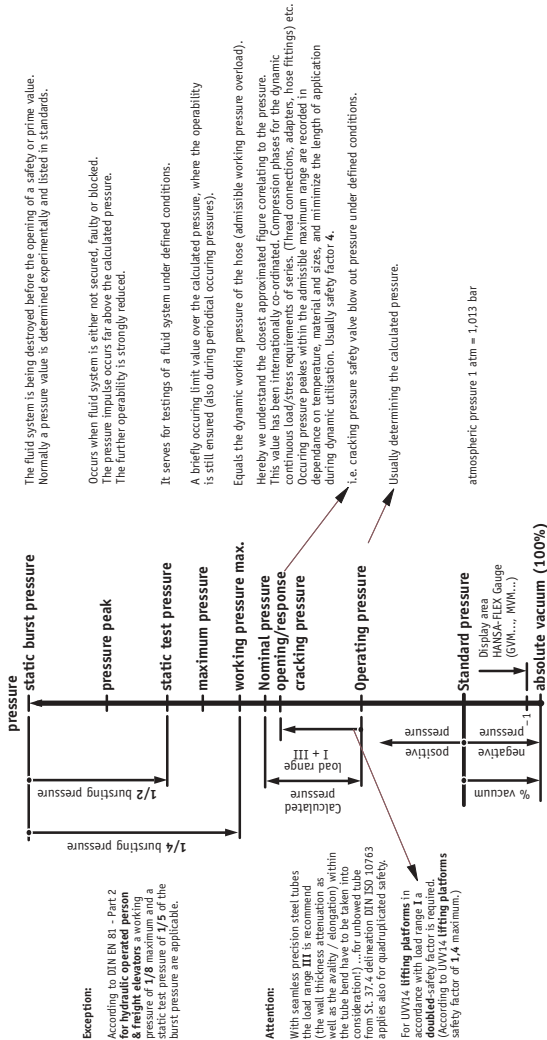

# Technical Information

## HANSA-FLEX Hose Connections

### 3.9 Cavitation

#### • Character of Cavitation

*In case the vapour pressure of a fluid decreases within the fluid velocity this liquid instantly evaporises within the limited area. Vapour-filled fluid cavities are then being formed. By finally reaching the original pressure values the vapour bubbles implode. Through this impact pressure waves develop with local peaks up to a couple of hundred bars and a frequency of a several thousand Hertz. Also by applications with inadmissably low suction pressures (0,8 down to 0,7 bar absolute) cavitations might occur. Dissolved air in oil is being discharged under negative pressure.*

*These bubbles get immediately and under the influence of temperature compressed again.*

#### • Effect of Cavitation

*The effect of these "hits" to the wall material surface is substantially degrading. Already within a few hours a perforating "woodpecking"-like attack to the surface initiates which leads to severe wall section breaks etc. Concussions with reaction forces also in higher ranges of magnitude might occur.*

#### • Causes for Cavitation

*Possible reasons for cavitation:*

- Sudden high fluid velocity due to bottlenecks and pressure surges
- High temperature of hydraulic fluids
- Velocity is too high due to alterations of the conveying quantity, drag and thus pressure loss within the suction compartment of the machinery
- Bad ventilation of the oil reservoir
- wide pressure differences
- condition of hydraulic fluid (age, share of oxygen)

#### • Possibilities for the reduction of cavitations

*Subsequent measurements to prevent cavitation:*

- low suctioning height
- sufficiently large conduction line calculation
- sufficiently measured suction filters
- smoothly processed surfaces
- small reduced amount of air in the oil
- possible pressure increase before hand on the suction side

## Technical Information

# HANSA-FLEX Hose Connections

### 3.10 Popcorning

#### • Reasons

The EPDM inner layer of the vapour elastomer hoses is water resistant (water expansion of the hose core). Following a renewed steam impingement after a standstill and the associated cooling the penetrated water evaporates immediately. The sudden volume expansion leads inevitably to structure damage in the internal area. This procedure is called Popcorning.

#### • Effects and limitations of use

The optimal application of the EPDM hoses is ensured with wet and saturated steam which is the direct area of the saturated steam curve.

In that mode also the limitations of use for steam hoses can be derived:

- hose type B 210° Celsius, 18 bar
- hose type A 170° Celsius, 8 bar

Dry and overheated steam harm the elastomer hose as well as hot water.

Therefore EPDM hoses should be utilised with hot water only up to max. 120° Celsius or 1 bar positive pressure.

Overheatings occur also directly after pressure reductions or with only partly opened stop valves.

Therefore a spontaneous decrease of pressure must be avoided at constant temperatures.

### 3.11 Electrostatic charge

#### 3.11.1 Character of electrostatic charge

Such loadings are electrical charges, which accumulate after a mechanical separation of homogeneous or heterogeneous materials on their surfaces.

A mechanical separation occurs:

- solid materials: stripping, reaming, attrition, milling, tipping
- fluids: flowing, tipping, spraying (charged fog)
- gases and steams: gas and steams do not get electrically charged in their purest form. It is however to be considered either solid or liquid contaminations or even solid or liquid proportions formed through condensation may develop electrostatic charge.

The emphasis hereby lie on purification processes with steam or water jet devices, paint spraying, solvent transportation as well as the conduction of fuel and petrol in solid and liquid form.

The level of the electrical loading depends on the intensity and the range of these separation processes which

## Technical Information

# HANSA-FLEX Hose Connections

however are independent of the conductivity of the assigned materials.

If the charging is accordingly strong, it comes to current discharge in the form of sparks, bundles or coronary unloadings and hereby to a possible inflammation of a combustible atmosphere.

Explosive unloadings can occur between an isolated or grounded conductive item and a

- charged isolated conductive object
- charged non-conductive material

The grounding therefor has a particular significance- this applies especially to the utilisation of not-conductive equipment items or in its combination with conductive equipment.

Principles herefor are:

- Guide lines „Static Electricity“, BGR 132 (ZH 1/200 so far)
- „Hose conductions – secure application“, ZH 1/134

### 3.11.2 Electrostatic charge within the conduction technique

Rechargeable materials, e.g. rubber and plastics, can be made sufficiently conductive by constructional means, e.g. metallic tension carriers or by additions such as soot.

The possibility of a reduced conductivity by damage of the tension carrier or the removal of the connection pressure hose fitting as well as by separations or structural alterations has to be taken into consideration. The extent of the loading depends strongly on the flow rate within the conduction line.

The loaded stream rises with increasing rate and at continuous velocity with increasing nominal size and increasing pipe diameter.

Chargings can also be observed when strong or sudden modification of the flow direction are being made.

The flow rate should not exceed 6m/sec in connection with the application of standard hoses.

The steam feed becomes rather critical due to the occurring high velocity rates determined through the adiabatic relaxation.

At a release velocities of more than 16m/sec forms an average. These relaxations then lead to an electric charge.

Therefore a special meaning is attached to the guarantee of the electrical conductivity of the hose lines or conductions.

The electrical resistance between the armatures of a hose line must therefore be either smaller or equivalent 106  $\Omega$  in a dry and stretched status.

## Technical Information

# HANSA-FLEX Hose Connections

### 3.11.3 Electrostatic charge in the non-conduction technique

*When banking, attenuating, cleaning and filling the containers and tanks dangerous chargings have to be taken into consideration. These discharging energies are sufficient, to ignite gas-steam or dust-air mixtures.*

*Dangerous areas are also the environments of open steam jets (steam jet devices) and radiating isolated conductors with the charged open jet caused by the very high exhaust velocities of steam from a nozzle and its relaxation. Dangerous discharge even occur within saturated steam at egression from a rubber hose. The water vapour in a container or a tank neither reduces the charging of the liquid nor serves to the reduction of the field strengths in a vapour room.*

### 3.11.4 Lengths and diameter alterations of hose lines

*It is well-known that hose lines alter in axial as well as in radial direction when they are subject to pressure loads which means their lengths are modified either positively or negatively. As a general rule an augmentation of the diameter occurs likewise.*

*This behaviour is by no means ideal as it is for steel springs though. The determination hereby are delivered upon thorough tests with an artefact, a so-called "Volumetric Expansion Test".*

*The either positive or negative modifications have to be considered when defining the entire hose line length in order to prevent the buckling as well as the sudden pull-out movement of the hose (interlock). The increase of the tube diameter interferes when the hose length has been calculated too narrowly and hose line mountings are inelastical or when the hose is utilised as control line. Pressure and volume are characteristic factors concerning the routing and therewith the characteristics of a control circuit.*

*Furthermore it has to be taken into account that desired volume increase may reduce maximum pressure values. (buffer)*

*Responsible for these occurrences are the braiding angle, the material and the brading type of the pressure carrier. The mechanical properties of the hose are determined through these three criteria and lead to different performances. Again pressure and nominal bore are further parameters to the length amendment of the hose line.*

*Ultimately the knowledge concerning breaking elongation as well as tearing strength serves for the calculation of the bursting pressure of the hose which subsequently after several tests is being registered into the regarding norm.*

*Vice versa of course technical specifications for a constructive design in relation with personal experiences within this specific field may result in a newly defined product.*

*In pertinent standards as well as in references of the respective suppliers numerical values are stated. These general values however can not substitute the values gained by experience and in practice about the axial elongations and reductions including the changes to the diameter. They solely give a hint that alterations do occur and are quoted in which value range they lie (maximum values as well).*

*For a qualitative validation and inspection it is to assume that a change of the volume always bears accordingly an alteration of the length as well as the diameter. The information available refer to a positive modification of the volume (cm<sup>3</sup>/m) and the diameter (%). For the calculation of changes to the diameter the indications of the modifications to the volume form the basis. Thus this user guide contains two different categories of marginal values (see table 1 + 2). There are: alteration to the length (+/-) extracted from the standard as well as the suppliers specifications, modifications to the diameter (+) as extreme marginal values without consideration of the axial alterations. A modification of length into a positive range is conjectural due to a neagtive development of the diameter. (exception).*

*It is a fact that especially for retrofits as well as for new assemblies these occurences are taken into consideration insufficiently and therefore the person responsible for maintainance should always double dreek all technical specification nevertheless. This is particularly the case when the necessary dimensioning of the hose line has to be carried out.*

*Whereas the specifications about the volume increase concerning the braiding angle (within its tolerance width between 50° and 60°) are unsuitable for the work in practice all specifications stated in coherence with the hose type though are much more significant. A braiding angle of 54,73°=54°44' causes the wire layer through the axial and the tangential forces of the fluid transmitting the pressure to be stressed identically. The hose adjusts to its largest volume capacity. This angle therefore is determined as the "Neutral Angle".*

# Technical Information

## HANSA-FLEX Hose Connections

**Chart 1: Changes to the length**

<b>Hose type</b>	<b>Changes to length in % (+/-)</b>
Fuel hose, SI 100	between -8 and 0
1 TE and 2 TE, TE 100 and TE 200	between -4 and +2
3 TE (up to DN 25), TE 300	between -4 and +2
3 TE (up to DN 32), TE 332	between 0 and +5
3 TE (up to DN 40), TE 340	between -4 and +2
3 TE (up to DN 50), TE 350	between 0 and +5
1 SN (up to DN 06), HD 100	between -6 and 0
1 SN (up to DN 08), HD 100	between -4 and +2
2 SN (up to DN 06), HD 200	between -6 and 0
2 SN (up to DN 08), HD 200	between -4 and +2
4 SP, HD 400	between -4 and +2
4 SH, HD 500	between -4 and +2
SAE100R15, HD 700	between -2 and +2
Thermoplastic (polyamide), TAF 100 and TBF 200	between 0 and +3
Thermoplastic (polyester), NY 100	between -3 and +1
Thermoplastic (teflon), TF 200 and TF 206	0
TF 208	-1,63

## Technical Information

### HANSA-FLEX Hose Connections

#### Chart 2: Changes to the diameter

Referring to the admissible working pressure according to EN... resp. DIN... as well as 1 m hose line length for the chosen hose sizes and types.

The alterations to the diameter are remote and can be equalised easily eg via elastical inserts within the relatively rigid tube clamps. However, a disregard in coherence with the dynamic stresses and the axial displacements however would be wrong.

The values for the modifications to the diameter have been ascertained independently from the length increase of the hose and solely determined via the volume amendment ( $\text{cm}^3/\text{m}$ ).

Hose type	admissible working pressure – bar	change of volume in + $\text{cm}^3/\text{m}$	change of diameter in + mm
<b>1 SN</b>			
HD 108	215	2,75	0,22
HD 110	180	2,80	0,19
HD 113	160	4,95	0,25
HD 120	105	7,60	0,25
HD 125	88	11,45	0,29
<b>2 SN</b>			
HD 208	350	3,65	0,29
HD 210	330	4,45	0,29
HD 213	275	5,80	0,29
HD 220	215	10,30	0,34
HD 225	165	15,75	0,39
<b>4 SP</b>			
HD 410	445	5,45	0,36
HD 413	415	9,90	0,49
HD 416	350	12,50	0,49
HD 420	350	14,50	0,48
HD 425	280	17,50	0,43

## Technical Information

### HANSA-FLEX Hose Connections

Hose type	admissible working pressure – bar	change of volume in + cm <sup>3</sup> /m	change of diameter in + mm			
<b>4 SH</b>						
HD 525	380	22,00	0,55			
HD 532	325	29,00	0,58			
HD 540	290	34,00	0,57			
<b>SAE100R15</b>						
HD 720	420	12,35	0,40			
HD 725	420	21,70	0,54			
HD 732	420	44,00	0,87			
HD 740	420	53,40	0,88			
<b>Thermoplastic</b>						
TAF 106	225 at 50° C	5,70	0,55			
TAF 108	200 at 50° C	8,50	0,60			
TAF 113	140 at 50° C	10,50	0,50			
TBF 208	330 at 50° C	7,50 estimated	0,57			
TBF 210	300 at 50° C	9,50 estimated	0,58			
<b>Alterations to the length and the outer diameter in dependance on the choice of hose type</b>						
Prerequisites: Modification of length and outer diameter when reading the admissible working pressure, stated within the standard as well as the supplies specifications						
Hose type	1SN / 1ST	2SN / 2ST	4SP / 4SH	SAE / R15	AF / BF	NY100
change of length in % up to DN 06	-6 up to 0	-6 up to 0				
change of length in % up to DN 08	-4 up to +2	-4 up to +2				
change of length in % DN independently			-4 up to +2	-2 up to +2	0 up to +3	-3 up to +1
change of outer diameter in mm	0,22-0,29	0,29-0,39	0,36-0,57	0,40-0,88	0,55-0,58	
Source: DIN 20022, 20023, SAE100R15, suppliers specifications						